

Acer TravelMate 3210Z Series

Service Guide

Service guide files and updates are available on the ACER/CSD web; for more information, please refer to <http://csd.acer.com.tw>

PRINTED IN TAIWAN

Revision History

Please refer to the table below for the updates made on TravelMate 3210Z service guide.

| Date | Chapter | Updates |
|------|---------|---------|
| | | |
| | | |
| | | |
| | | |
| | | |
| | | |

Copyright

Copyright © 2006 by Acer Incorporated. All rights reserved. No part of this publication may be reproduced, transmitted, transcribed, stored in a retrieval system, or translated into any language or computer language, in any form or by any means, electronic, mechanical, magnetic, optical, chemical, manual or otherwise, without the prior written permission of Acer Incorporated.

Disclaimer

The information in this guide is subject to change without notice.

Acer Incorporated makes no representations or warranties, either expressed or implied, with respect to the contents hereof and specifically disclaims any warranties of merchantability or fitness for any particular purpose. Any Acer Incorporated software described in this manual is sold or licensed "as is". Should the programs prove defective following their purchase, the buyer (and not Acer Incorporated, its distributor, or its dealer) assumes the entire cost of all necessary servicing, repair, and any incidental or consequential damages resulting from any defect in the software.

Acer is a registered trademark of Acer Corporation.

Intel is a registered trademark of Intel Corporation.

Pentium and Pentium II/III are trademarks of Intel Corporation.

Other brand and product names are trademarks and/or registered trademarks of their respective holders.

Conventions

The following conventions are used in this manual:

| | |
|------------------------|--|
| SCREEN MESSAGES | Denotes actual messages that appear on screen. |
| NOTE | Gives bits and pieces of additional information related to the current topic. |
| WARNING | Alerts you to any damage that might result from doing or not doing specific actions. |
| CAUTION | Gives precautionary measures to avoid possible hardware or software problems. |
| IMPORTANT | Reminds you to do specific actions relevant to the accomplishment of procedures. |

Preface

Before using this information and the product it supports, please read the following general information.

1. This Service Guide provides you with all technical information relating to the BASIC CONFIGURATION decided for Acer's "global" product offering. To better fit local market requirements and enhance product competitiveness, your regional office MAY have decided to extend the functionality of a machine (e.g. add-on card, modem, or extra memory capability). These LOCALIZED FEATURES will NOT be covered in this generic service guide. In such cases, please contact your regional offices or the responsible personnel/channel to provide you with further technical details.
2. Please note WHEN ORDERING FRU PARTS, that you should check the most up-to-date information available on your regional web or channel. If, for whatever reason, a part number change is made, it will not be noted in the printed Service Guide. For ACER-AUTHORIZED SERVICE PROVIDERS, your Acer office may have a DIFFERENT part number code to those given in the FRU list of this printed Service Guide. You MUST use the list provided by your regional Acer office to order FRU parts for repair and service of customer machines.

Table of Contents

| | | |
|------------------|--|-----------|
| Chapter 1 | System Specifications | 1 |
| | Features | 1 |
| | System Block Diagram | 3 |
| | Board Layout | 4 |
| | Top View | 4 |
| | Bottom View | 5 |
| | A TravelMate tour | 6 |
| | Front View | 6 |
| | Closed Front View | 7 |
| | Left View | 8 |
| | Right View | 9 |
| | Rear Panel | 10 |
| | Bottom Panel | 11 |
| | Indicators | 12 |
| | Easy-launch Keys | 13 |
| | Touchpad | 14 |
| | Touchpad Basics | 14 |
| | Using the Keyboard | 16 |
| | Lock Keys and embedded numeric keypad | 16 |
| | Windows Keys | 17 |
| | Hot Keys | 18 |
| | Special Key | 20 |
| | Hardware Specifications and Configurations | 21 |
| Chapter 3 | System Utilities | 31 |
| | BIOS Setup Utility | 31 |
| | Navigating the BIOS Utility | 32 |
| | Main | 33 |
| | Advanced | 37 |
| | Security | 38 |
| | Boot | 39 |
| | Exit | 40 |
| | BIOS Flash Utility | 41 |
| Chapter 3 | Machine Disassembly and Replacement | 43 |
| | General Information | 44 |
| | Before You Begin | 44 |
| | Disassembly Procedure Flowchart | 45 |
| | Removing the Battery Pack | 47 |
| | Removing the Wireless LAN Card/the HDD Module/the Memory/ the CPU/the ODD Module and the LCD Module | 48 |
| | Removing the Wireless LAN Card and the HDD Module | 48 |
| | Removing the Memory and the CPU | 48 |
| | Removing the ODD Module and the LCD module | 49 |
| | Disassembling the Main Unit | 52 |
| | Separate the Main Unit Into the Upper and the Lower Case Assembly | 52 |
| | Disassembling the Upper Case Assembly | 52 |
| | Disassembling the Lower Case Assembly | 53 |
| | Disassembling the LCD Module | 55 |
| | Disassembling the External Modules | 56 |
| | Disassembling the HDD Module | 56 |
| | Disassembling the ODD Module | 56 |

Table of Contents

| | | |
|------------------|--|-----------|
| Chapter 4 | Troubleshooting | 57 |
| | System Check Procedures | 58 |
| | External Diskette Drive Check | 58 |
| | External CD-ROM Drive Check | 58 |
| | Keyboard or Auxiliary Input Device Check | 58 |
| | Memory check | 58 |
| | Power System Check | 59 |
| | Touchpad check | 60 |
| | Power-On Self-Test (POST) Error Message | 61 |
| | Index of Error Messages | 62 |
| | Insyde MobilePro BIOS POST Beep Code and POST Messages | 64 |
| | Index of Symptom-to-FRU Error Message | 66 |
| | Intermittent Problems | 70 |
| | Undetermined Problems | 71 |
| Chapter 5 | Jumper and Connector Locations | 73 |
| | Top View | 73 |
| | Bottom View | 74 |
| Chapter 6 | FRU (Field Replaceable Unit) List | 75 |
| | Exploded Diagram | 76 |
| | The System | 76 |
| | Upper Case Assembly | 77 |
| | Lower Case Assembly | 78 |
| | LCD Module | 79 |
| | HDD Module | 80 |
| | ODD Module | 80 |

System Specifications

Features

Below is a brief summary of the computer's many features:

Platform and memory

- Intel® Centrino™ Mobile Technology, featuring:
 - ▶ Intel® Pentium® M Processor 740/750/760/770/780 (2 MB L2 cache, 1.73/1.86/2/2.13/2.26 GHz, 533 MHz FSB)
 - ▶ Intel® Pentium® M Processor 735/735A (2MB L2 cache, 1.70 GHz, 400 MHz FSB)
 - ▶ Intel® 915GM/PM Express chipset
 - ▶ Wireless solution: integrated Intel® PRO/Wireless 2200BG network connection (dual-band 802.11b/g) Wi-Fi® CERTIFIED™ solution, supporting Acer SignalUp wireless technology
- 256/512 MB of DDR2 400/533 MHz memory, upgradeable to 2 GB using two soDIMM modules (dual-channel support)

Display

- 14.1 WXGA color TFT LCD, 1280 x 800 resolution; 16:10 viewing ratio, supporting simultaneous multi-window viewing on dual displays via Acer GridVista™
- 16.7 million colors
- Intel® 915GM integrated 3D graphics, featuring Intel® Graphics Media Accelerator 900 and up to 128 MB of VRAM, supporting Microsoft® DirectX® 9.0 and dual independent display (UMA models)
- Intel® 915PM with ATI Mobility™ Radeon® X1300 256/512 MB HyperMemory™, supporting ATI PowerPlay™, Microsoft® DirectX® 9.0, PCI Express® and DualView™ (discrete models)
- MPEG-2/DVD hardware-assisted capability

Storage subsystem

- 40/60/80/100 GB ATA/100 hard disk drive
- Optical drive options:
 - ▶ DVD-Super Multi double layer
 - ▶ DVD-Dual double layer
 - ▶ DVD/CD-RW combo

Input devices

- Acer FineTouch™ keyboard
- 84/85-key keyboard
- Touchpad with 4-way integrated scroll button
- Four easy-launch buttons
- Two front-access LED-buttons: WLAN and Bluetooth®
- 12 function keys, four cursor keys, two Windows® keys, hotkey controls, embedded numeric keypad, international language support

Audio

- Audio system with two built-in speakers
- Built-in microphone
- Intel® AC'97 audio support
- Sound Blaster Pro™ and MS-Sound compatible

Communication

- Modem: 56K ITU V.92 modem with PTT approval; wake-on ring ready
- LAN: 10/100 Mbps Fast Ethernet; wake-on ring ready
- WLAN: integrated Intel® PRO/Wireless 2200BG network connection (dual-band 802.11b/g) Wi-Fi CERTIFIED™ solution supporting Acer SignalUp™ wireless technology
- WPAN: integrated Bluetooth®

Human-centric design and ergonomics

- Rugged, yet extremely portable design
- Stylish appearance
- Full-size keyboard with four programmable launch keys
- Ergonomically-centered touchpad pointing device
- Acer FineTouch keyboard with a 5-degree curve
- Internet 4-way scroll button

I/O Ports

- Three USB 2.0 ports
- PC Card slot (one Type II)
- External display (VGA) port
- Headphones/speaker/line-out port
- Microphone/line-in jack
- Ethernet (RJ-45) port
- Modem (RJ-11) port
- DC-in jack for AC adaptor

Environment

- Temperature:
 - ✦ Operating: 5° C to 35° C
 - ✦ Non-operating -20° C to 65° C
- Humidity (non-condensing):
 - ✦ Operating: 20% to 80%
 - ✦ Non-operating 20% to 80%

System Block Diagram

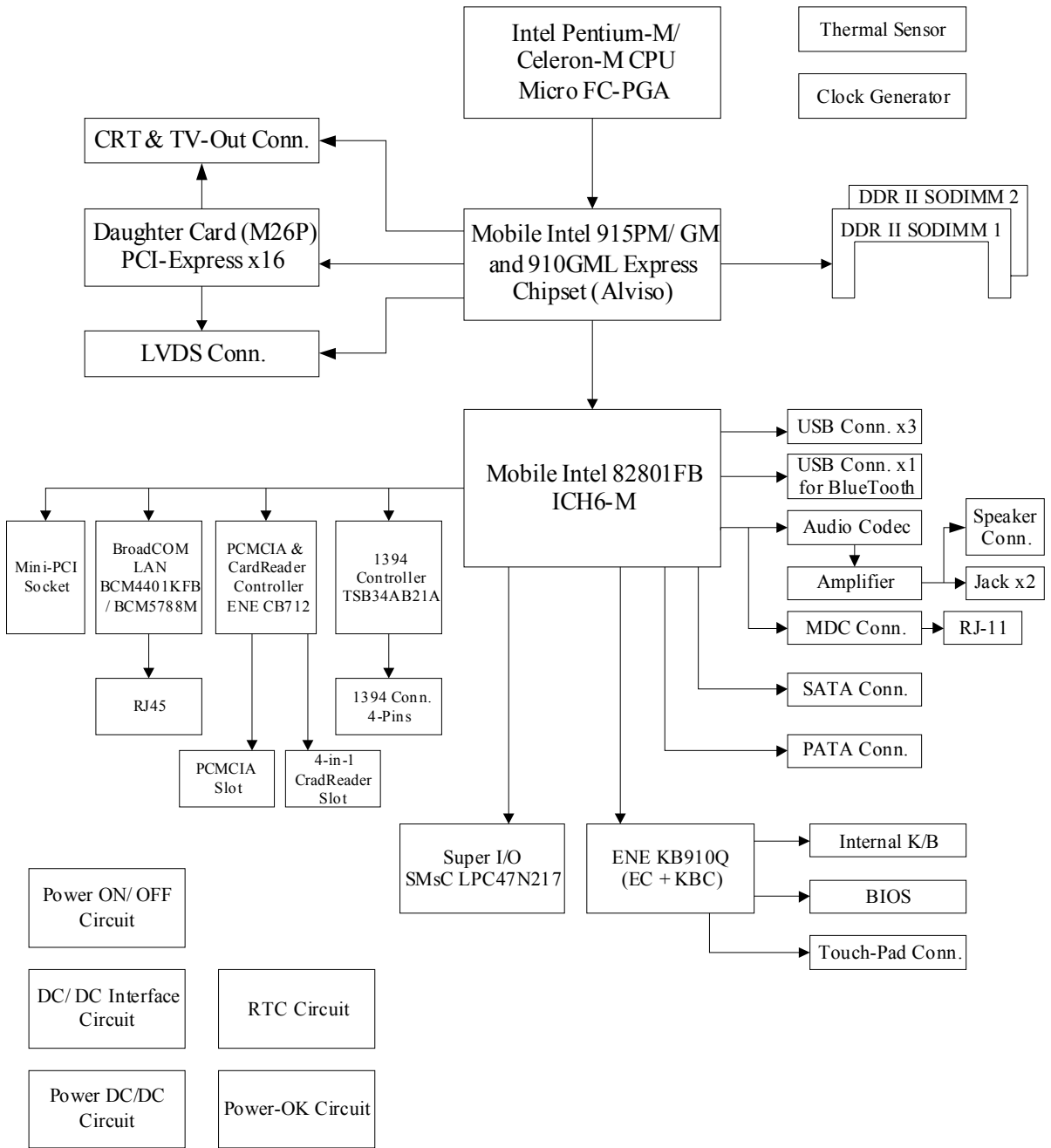

Board Layout

Top View

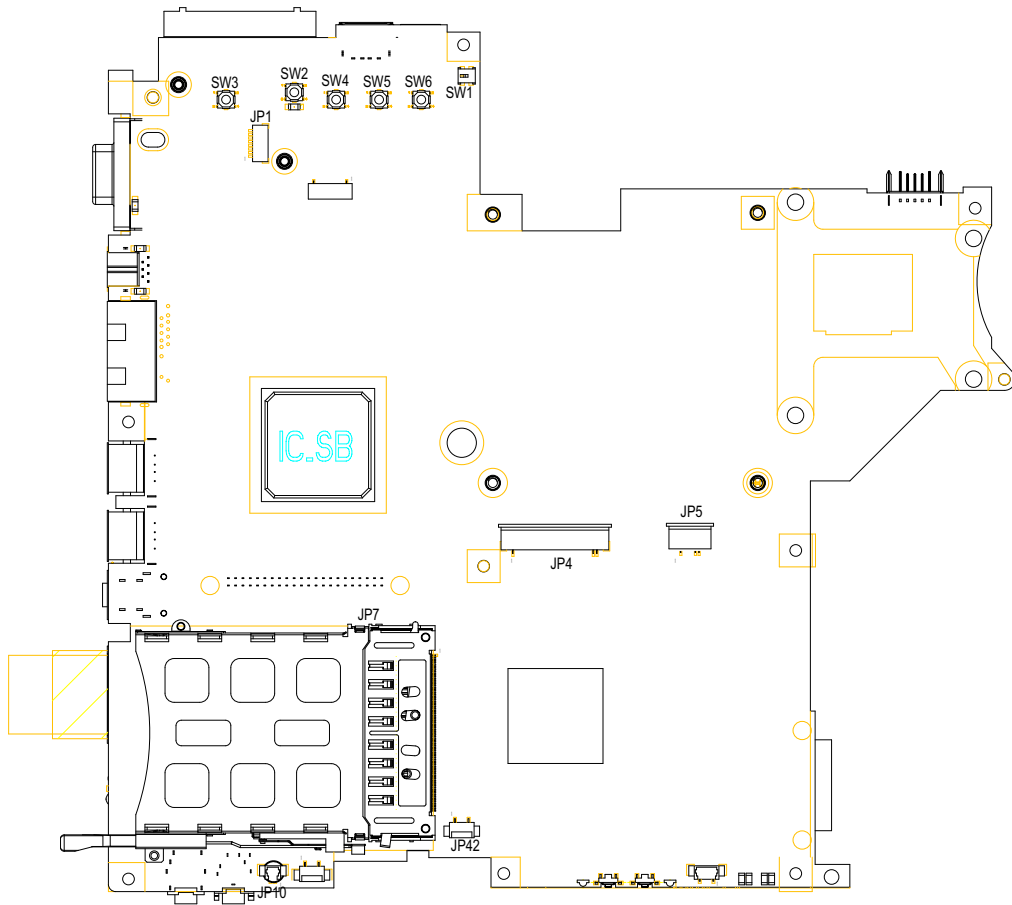

| | | | |
|-----|--------------------------|------|----------------------|
| SW3 | Power Switch | SW1 | Lid Switch |
| JP1 | Bluetooth Connector | JP5 | Touchpad Connector |
| SW2 | E-mail Switch | JP4 | Keyboard Connector |
| SW4 | Internet Browser Switch | JP42 | Speaker Connector |
| SW5 | Emanager Switch | JP7 | PCMCIA Slot |
| SW6 | User Programmable Switch | JP10 | Microphone Connector |

Bottom View

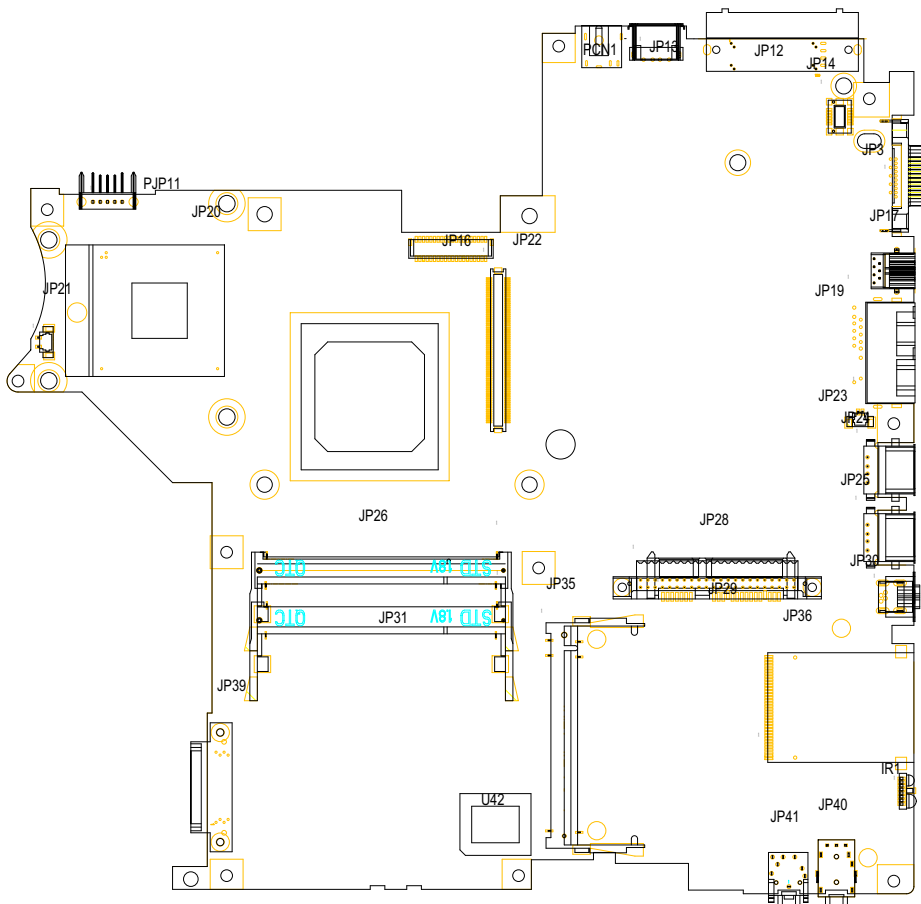

| | | | |
|-------|---|------|--|
| JP21 | Fan Connector | JP24 | USB Port |
| PJP11 | Battery Connector | JP25 | USB Port |
| JP20 | CPU Socket | JP30 | IEEE 1394 Port (No IEEE 1394 Port for this model) |
| JP16 | LVDS Connector | JP36 | Card Reader Connector(No Card Reader module for this model) |
| JP22 | VGA Board Connector | IR | Infrared Receiver (No FIR function for this model) |
| PCN1 | AC-IN | JP40 | Headphone out/line-out Jack |
| JP13 | USB Port | JP41 | Mic-in Jack |
| JP12 | Acer ezDock (No ezDock for this model) | JP28 | HDD Connector |
| JP14 | Modem Board Connector | JP35 | Wireless LAN Card Connector |
| JP3 | External Display Port | U42 | BIOS |
| JP17 | S-Video Port | JP26 | DDR2 Socket |
| JP19 | RJ11/RJ45 | JP31 | DDR2 Socket |
| JP23 | Modem Cable Connector | JP39 | ODD Connector |

A TravelMate tour

After knowing your computer features, let us show you around your new TravelMate computer.







Front View

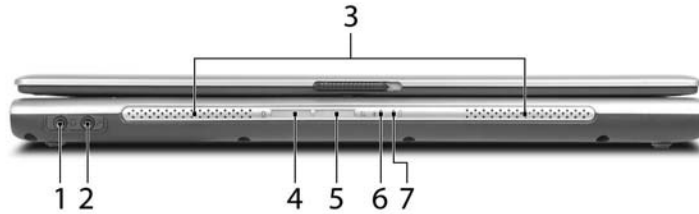

| # | Icon | Item | Description |
|---|------|--|---|
| 1 | | Display screen | Also called LCD (liquid-crystal display), displays computer output. |
| 2 | | Power button | Turns the computer on and off. |
| 3 | | Launch keys | Buttons for launching frequently used programs. See "Launch keys" section for more details. |
| 4 | | Microphone | Internal microphone for sound recording. |
| 5 | | Status indicators | Light-Emitting Diodes (LEDs) that turn on and off to show the status of the computer's functions and components. |
| 6 | | Palmrest | Comfortable support area for our hands when you use the computer. |
| 7 | | Click buttons (left, center and right) | The left and right buttons function like the left and right mouse buttons; the center button serves as a 4-way scroll button. |
| 8 | | Touchpad | Touch-sensitive pointing device which functions like a computer mouse. |
| 9 | | Keyboard | For entering data into your computer. |

Closed Front View



| # | Icon | Item | Description |
|---|---|--|---|
| 1 |  | headphones/speaker/line-out jack with S/PDIF support | Connects to audio line-out devices (e.g., speakers, headphones). |
| 2 |  | Microphone/line-in jack | Accepts inputs from external microphone. |
| 3 | | Speakers | Left and right speakers deliver stereo audio output. |
| 4 |  | Bluetooth® communication button/indicator | Press to enable/disable Bluetooth function. Lights to indicate the status of Bluetooth communications (optional). |
| 5 |  | Wireless communication button/indicator | Press to enable/disable Wireless function. Lights to indicate the status of wireless LAN communications (optional). |
| 6 |  | Power indicator | Lights when the computer is on. |
| 7 |  | Battery indicator | Lights when the battery is being charged |

Left View

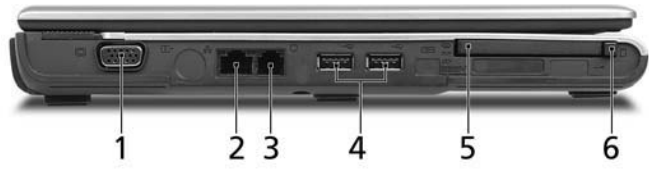

| # | Icon | Item | Description |
|---|------|---------------------------|--|
| 1 | | External display port | Connects a display device (e.g., external monitor, LCD projector). |
| 2 | | Network jack | Connects to an Ethernet 10/100/1000-based network. |
| 3 | | Modem jack | Connects to a phone line. |
| 4 | | Two USB 2.0 ports | Connects to USB 2.0 devices (e.g., USB mouse, USB camera). |
| 5 | | PC Card slot | Connects to one Type II PC Card. |
| 6 | | PC Card slot eject button | Ejects the PC Card from the slot. |



Right View



| # | Icon | Item | Description |
|---|---|----------------------------|--|
| 1 | | Optical drive | Internal optical drive; accepts CDs or DVDs depending on the optical drive type. |
| 2 | | LED indicator | Lights up when the optical drive is active. |
| 3 | | Optical drive eject button | Ejects the optical drive tray from the drive. |
| 4 | | Emergency eject hole | Ejects the optical drive tray when the computer is turned off. |
| 5 | | Ventilation slots | Enable the computer to stay cool, even after prolonged use. |
| 6 |  | Security Keylock | Connects to a Kensington-compatible computer security lock. |

Rear Panel



| # | Icon | Item | Description |
|---|---|-------------|---|
| 1 | | Battery bay | Houses the computer's battery pack. |
| 2 |  | Power jack | Connects to an AC adaptor. |
| 3 |  | | Connect to USB 2.0 devices (e.g., USB mouse, USB camera). |

Bottom Panel









| # | Item | Description |
|---|-----------------------|---|
| 1 | Battery bay | Houses the computer's battery pack. |
| 2 | Battery lock | Locks the battery in place. |
| 3 | Cooling fan | Helps keep the computer cool. Note: Do not cover or obstruct the opening of the fan. |
| 4 | Memory compartment | Houses the computer's main memory. |
| 5 | Hard disk bay | Houses the computer's hard disk (secured by two screws). |
| 6 | Battery release latch | Releases the battery for removal. |

Indicators

The computer has three easy-to-read status indicators on the upper-left above the keyboard, and four on the front panel.



The power, battery and wireless communication status indicators are visible even when the LCD display is closed.

| Icon | Function | Description |
|---|----------------|--|
|  | Cap lock | Lights when Cap Lock is activated |
|  | Num lock | Lights when Num Lock is activated. |
|  | Media Activity | Indicates when the hard disc or optical drive is active. |
|  | Bluetooth | Indicates the status of Bluetooth communication. |
|  | Wireless LAN | Indicates the status of wireless LAN communication. |
|  | Power | Lights up when the computer is on. |
|  | Battery | Lights up when the battery is being charged. |

NOTE: 1. **Charging:** The light shows amber when the battery is charging. 2. **Fully charged:** The light shows green when in AC mode.

Easy-launch Keys

Located above the keyboard are four buttons. These buttons are called easy-launch buttons. They are mail, Web browser, Empowering Key < *e* > and one user-programmable button.

Press < *e* > to run the Acer Empowering Technology. The mail and web browser buttons are pre-set to email and Internet programs, but can be reset by users. To set the Web Browser, mail and programmable buttons, run the Acer Launch Manager.



| Launch key | Default application |
|-------------|---------------------------------------|
| Mail | Email application (user-programmable) |
| Web browser | Internet browser (user-programmable) |
| <i>e</i> | Acer eManager (user-programmable) |
| P | User-programmable |

Touchpad

The built-in touchpad is a pointing device that senses movement on its surface. This means the cursor responds as you move your finger across the surface of the touchpad. The central location on the palmrest provides optimum comfort and support.



Touchpad Basics

The following teaches you how to use the touchpad:



- ❑ Move your finger across the touchpad (2) to move the cursor.
- ❑ Press the left (1) and right (4) buttons located beneath the touchpad to perform selection and execution functions. These two buttons are similar to the left and right buttons on a mouse. Tapping on the touchpad is the same as clicking the left button.
- ❑ Use the 4-way scroll (3) button to scroll up or down and move left or right a page. This button mimics your cursor pressing on the right scroll bar of Windows applications.

| Function | Left Button (1) | Right Button (4) | Main touchpad (2) | Center button (3) |
|----------|---------------------|------------------|---|-------------------|
| Execute | Click twice quickly | | Tap twice (at the same speed as double-clicking the mouse button) | |
| Select | Click once | | Tap once | |

| Function | Left Button (1) | Right Button (4) | Main touchpad (2) | Center button (3) |
|---------------------|--|------------------|--|--|
| Drag | Click and hold, then use finger to drag the cursor on the touchpad | | Tap twice (at the same speed as double-clicking a mouse button) then hold finger to the touchpad on the second tap to drag the cursor. | |
| Access context menu | | Click once | | |
| Scroll | | | | Click and hold to move up/down/left/right. |

NOTE: Keep your fingers dry and clean when using the touchpad. Also keep the touchpad dry and clean. The touchpad is sensitive to finger movements. Hence, the lighter the touch, the better the response. Tapping too hard will not increase the touchpad's responsiveness.

Using the Keyboard

The keyboard has full-sized keys and an embedded keypad, separate cursor keys, two Windows keys and twelve function keys.

Lock Keys and embedded numeric keypad

The keyboard has three lock keys which you can toggle on and off.











| Lock Key | Description |
|---------------------------|--|
| Caps Lock | When Caps Lock is on, all alphabetic characters typed are in uppercase. |
| Num lock <Fn>+<F11> | When Num Lock is on, the embedded keypad is in numeric mode. The keys function as a calculator (complete with the arithmetic operators +, -, *, and /). Use this mode when you need to do a lot of numeric data entry. A better solution would be to connect an external keypad. |
| Scroll lock <Fn>+<F12> | When Scroll Lock is on, the screen moves one line up or down when you press the up or down arrow keys respectively. Scroll Lock does not work with some applications. |

The embedded numeric keypad functions like a desktop numeric keypad. It is indicated by small characters located on the upper right corner of the keycaps. To simplify the keyboard legend, cursor-control key symbols are not printed on the keys.

| Desired Access | Num Lock On | Num Lock Off |
|--|--|--|
| Number keys on embedded keypad | Type numbers in a normal manner. | |
| Cursor-control keys on embedded keypad | Hold <Shift> while using cursor-control keys. | Hold <Fn> while using cursor-control keys. |
| Main keyboard keys | Hold <Fn> while typing letters on embedded keypad. | Type the letters in a normal manner. |

Windows Keys

The keyboard has two keys that perform Windows-specific functions.

| Key | Icon | Description |
|--|------|---|
| Windows key  | | <p>Pressed alone, this key has the same effect as clicking on the Windows Start button; it launches the Start menu. It can also be used with other keys to provide a variety of function:</p> <ul style="list-style-type: none"> + <Tab> Activates next taskbar button. + <E> Opens the My Computer window + <F1> Opens Help and Support. + <F> Opens the Find: All Files dialog box. + <R> Opens the Run dialog box. + <M> Minimizes all windows. <p><Shift>+  + <M> Undoes the minimize all windows action.</p> |
| Application key | | <p>This key has the same effect as clicking the right mouse button; it opens the application's context menu.</p> |







Hot Keys

The computer employs hotkeys or key combinations to access most of the computer's controls like screen brightness, volume output and the BIOS utility.

To activate hot keys, press and hold the <Fn> key before pressing the other key in the hotkey combination.



| Hot Key | Icon | Function | Description |
|---------|----------------|-----------------------|---|
| Fn-F1 | ? | Hot key help | Displays help on hot keys. |
| Fn-F2 | | Acer eSetting | Launches the Acer eSettings in Acer eManager. |
| Fn-F3 | | Acer ePowerManagement | Launches the Acer ePowerManagement in Acer eManager. |
| Fn-F4 | Z ^z | Sleep | Puts the computer in Sleep mode. |
| Fn-F5 | | Display toggle | Switches display output between the display screen, external monitor (if connected) and both. |
| Fn-F6 | | Screen blank | Turns the display screen backlight off to save power. Press any key to return. |
| Fn-F7 | | Touchpad toggle | Turns the internal touchpad on and off. |
| Fn-F8 | | Speaker toggle | Turns the speakers on and off. |
| Fn-F9 | | Volume up | Increases the speaker volume. |

| Hot Key | Icon | Function | Description |
|---|---|-----------------|----------------------------------|
| Fn-  |  | Volume down | Decreases the speaker volume. |
| Fn-  |  | Brightness up | Increases the screen brightness. |
| Fn-  |  | Brightness down | Decreases the screen brightness |

Special Key

You can locate the Euro symbol and US dollar sign at the upper-center and/or bottom-right of your keyboard. To type:



The Euro symbol

1. Open a text editor or word processor.
2. Either directly press the <€> symbol at the bottom-right of the keyboard, or hold <Alt Gr> and then press the <5> symbol at the upper-center of the keyboard.

The US dollar sign

1. Open a text editor or word processor.
2. Either directly press the <\$> key at the bottom-right of the keyboard, or hold <Shift> and then press the <4> key at the upper-center of the keyboard.

NOTE: This function varies by the operating system version.

NOTE: Some fonts and software do not support the Euro symbol. Please refer to www.microsoft.com/typography/faq/faq12.htm for more information.

Hardware Specifications and Configurations

Processor

| Item | Specification |
|------------------|---|
| CPU type | Intel® Pentium® M Processor 740/750/760/770/780 (2 MB L2 cache, 1.73/1.86/2/2.13/2.26 GHz, 533 MHz FSB) Intel® Pentium® M Processor 735/735A (2MB L2 cache, 1.70 GHz, 400 MHz FSB) |
| Core logic | Intel® 915GM/PM+Intel ICH6-M (Mobile Intel 82801FB) |
| CPU package | Intel socketable 478pin Micro-BGA |
| CPU core voltage | 1.308V (highest frequency mode) to 0.956V (low frequency mode) 0.748V (deeper sleep mode) |

BIOS

| Item | Specification |
|-----------------------|--|
| BIOS vendor | Insyde |
| BIOS Version | v1.10 |
| BIOS ROM type | Flash Memory |
| BIOS ROM size | 512KB |
| BIOS package | 32-pin PLCC |
| Supported protocols | ACPI 2.0, PC 2001 ready, SM BIOS 2.3, IEEE1284-ECP/EPP, PCI 2.2, PnP 1.0a, DMI 2.0, PS/2 keyboard and mouse, USB 2.0, VGA BIOS, CD-ROM bootable, IEEE 1394, SMB (system management bus), WFM 2.0 ready |
| BIOS password control | Set by setup manual |

Second Level Cache

| Item | Specification |
|-------------------------|---------------------|
| Cache controller | Built-in CPU |
| Cache size | 2MB |
| 1st level cache control | Always enabled |
| 2st level cache control | Always enabled |
| Cache scheme control | Fixed in write-back |

System Memory

| Item | Specification |
|---------------------------------|--|
| Memory controller | Intel® 915GM/PM |
| Memory size | 0MB (no on-board memory) |
| DIMM socket number | 2 sockets |
| Supports memory size per socket | 1024MB |
| Supports maximum memory size | 2G (by two 1024MB SO-DIMM module) |
| Supports DIMM type | DDR2 |
| Supports DIMM Speed | 400 MHz/533 MHz |
| Supports DIMM voltage | 2.5V and 1.25V |
| Supports DIMM package | 200-pin soDIMM |
| Memory module combinations | You can install memory modules in any combinations as long as they match the above specifications. |

Memory Combinations

| Slot 1 | Slot 2 | Total Memory |
|--------|--------|--------------|
| 0MB | 128MB | 128MB |
| 0MB | 256MB | 256MB |
| 0MB | 512MB | 512MB |
| 0MB | 1024MB | 1024MB |
| 128MB | 128MB | 256MB |
| 128MB | 256MB | 384MB |
| 128MB | 512MB | 640MB |
| 1284MB | 1024MB | 1152MB |
| 256MB | 128MB | 384MB |
| 256MB | 256MB | 512MB |
| 256MB | 512MB | 768MB |
| 256MB | 1024MB | 1280MB |
| 512MB | 128MB | 640MB |
| 512MB | 256MB | 768MB |
| 512MB | 512MB | 1024MB |
| 512MB | 1024MB | 1536MB |
| 1024MB | 0MB | 1024MB |
| 1024MB | 128MB | 1125MB |
| 1024MB | 256MB | 1280MB |
| 1024MB | 512MB | 1536MB |
| 1024MB | 1024MB | 2048MB |

NOTE: Above table lists some system memory configurations. You may combine DIMMs with various capacities to form other combinations. On above table, the configuration of slot 1 and slot 2 could be reversed.

LAN Interface

| Item | Specification |
|------------------------|---|
| Chipset | BCM4401KFB |
| Supports LAN protocol | 10/100Mbps |
| LAN connector type | RJ45 |
| LAN connector location | Left side |
| Features | Integrated 10/100 BASE-T transceiver Wake on LAN support compliant with ACPI 2.0 PCI v2.3 |

IR Interface (No IR Interface for this model)

| Item | Specification |
|-------------|-----------------|
| Part name | VISHAY TFU6102F |
| Package | 8-pin SMT type |
| Performance | 4Mbit/s |
| Compliant | IrDA 1.1 |

Modem Interface

| Item | Specification |
|---------------------------------|---------------|
| Data modem data baud rate (bps) | 56K |

Modem Interface

| Item | Specification |
|--------------------------|---------------|
| Supports modem protocol | V.92 |
| Modem connector type | RJ11 |
| Modem connector location | Left side |

Bluetooth Interface

| Item | Specification |
|--------------------------------------|--|
| Chipset/Vendor for Wireless LAN Card | built-in Mobile Intel® 82801FB (ICH6-M)/WNC |
| Data throughput | 723 bps (full speed data rate) |
| Protocol | Bluetooth 1.1 (Upgradeable to Bluetooth 1.2 when SIG specification is ratified). |
| Interface | USB 1.1 |
| Connector type | Mini-USB |

Wireless Module 802.11b/g (optional device)

| Item | Specification |
|-----------------|---|
| Chipset | built-in Mobile Intel® 82801FB (ICH6-M) |
| Data throughput | 11~54 Mbps |
| Protocol | 802.11b+g |
| Interface | Mini-PCI type II |

Hard Disk Drive Interface

| Item | Specification | | | |
|--|--|---|--|---|
| Vendor & Model Name | SEAGATE ST94019A Toshiba Pluto MK4025GAS | SEAGATE N2 ST960821A Toshiba Pluto MK6025GAS | SEAGATE N2 ST9808210A Toshiba Pluto MK8025GAS | SEAGATE ST9100822A TOSHIBA PLUTO MK1031GAS |
| Capacity (MB) | 40000 | 60000 | 80000 | 100000 |
| Bytes per sector | 512 | 512 | 512 | 512 |
| Data heads | 2/2 | 3/4 | 4/4 | 4/4 |
| Drive Format | | | | |
| Disks | 1/1 | 2/2 | 2/2 | 2/2 |
| Spindle speed (RPM) | 4200/4200 RPM | 4200/4200 RPM | 4200/4200 RPM | 4200/4200 RPM |
| Performance Specifications | | | | |
| Buffer size | 2MB/8192KB | 8192KB | 8192KB | 8192KB |
| Interface | ATA/ATAPI-6; ATA-6 | ATA/ATAPI-6; ATA-6 | ATA/ATA-6; ATA-6 | ATA/ATA-6; ATA-6 |
| Max. media transfer rate (disk-buffer, Mbytes/s) | 372 | 350 | 350 | 373 |
| Data transfer rate (host~buffer, Mbytes/s) | 100 MB/Sec. Ultra DMA mode-5 | 100 MB/Sec. Ultra DMA mode-5 | 100 MB/Sec. Ultra DMA mode-5 | 100 MB/Sec. Ultra DMA mode-5 |
| DC Power Requirements | | | | |

Hard Disk Drive Interface

| Item | Specification | | | |
|-------------------|---------------|---------------|---------------|---------------|
| Voltage tolerance | 5V(DC) +/- 5% | 5V(DC) +/- 5% | 5V(DC) +/- 5% | 5V(DC) +/- 5% |

Combo Drive Interface

| Item | Specification |
|---------------------------|--|
| Vendor & model name | Philips SCB5265+UJDA770 |
| Performance Specification | With CD Diskette With DVD Diskette |
| Transfer rate (KB/sec) | Sustained: Max 3.6Mbytes/sec Sustained: Max 10.8Mbytes/sec |
| Buffer Memory | 2MB |
| Interface | Enhanced IDE(ATAPI) compatible |
| Applicable disc format | Read: DVD: DVD-ROM, (DVD-5, DVD-9, DVD-10, DVD-18), DVD-Video, DVD-R (3.95 and 4.7G), DVD-RW, DVD+R, DVD+RW, Multi-Border DVD-R/DVD-RW, Multi-Session DVD+R, DVD+RW and DVD-RAM (optional) CD: CD-DA, CD-ROM Mode-1, CD-ROM/XA Mode-2 Form-1 and Mode-2 Form-2, CD-i Ready, Video-CD (MPEG-1), Karaoke CD, Super Video CD, Photo-CD, Enhanced CD, CD Plus, CD Extra, i-trax CD, CD-Text, CD-R, CD-RW Write: CD-DA, CD-ROM Mode-1CD-ROM/XA Mode-2 Form-1 and Mode-2 Form-2, CD-i, Video-CD, CD-Text |
| Loading mechanism | Load: Manual Release: (a) Electrical Release (Release Button) (b) Release by ATAPI command (c) Emergency Release |
| Power Requirement | |
| Input Voltage | 5 V +/- 5 % (Operating) |

DVD-Dual Interface

| Item | Specification |
|---|--|
| Vendor & model name | DVD Dual Pioneer DVR-K15RA DVD Dual Pioneer DVR-K05RA LiteOn SOSW-833S Panasonic UJ-845 |
| Performance Specification | With CD Diskette With DVD Diskette |
| Transfer rate (KB/sec) | Sustained: Max 3.6Mbytes/sec Sustained: Max 10.8Mbytes/sec |
| Buffer Memory | 2MBytes |
| Interface | Enhanced IDE(ATAPI) compatible |
| Applicable disc format for LiteOn SOSW-833S | Read: DVD: DVD single/dual layer (PTP, OTP), DVD-R (3.9G/4.7G), DVD-R multi-borders, DVD-R Double Layer, DVD+R, DVD+R multi-sessions, DVD+R Double Layer, DVD-RW, and DVD+RW discs with diameter of 8 or 12cm CD: CD-DA, CD-ROM, CD-ROM/XA, Photo-CD, Multi-session, Karaoke-CD, Video-CD, CD-I FMV, CD Extra, CD Plus, CD-R, and CD-RW discs of 8 or 12 cm diameter |

DVD-Dual Interface

| Item | Specification |
|--|---|
| Applicable disc format for Panasonic UJ-845 | <p>Read:</p> <p>DVD: DVD-5, 9,10,18, DVD-R (3.95G/4.7G), DVD-RW, DVD_RAM (4.7G), DVD+R, DVD+RW</p> <p>CD: CD-Audio, CD-ROM (mode1 and mode 2), CD-ROM XA (mode 2, form 1 and form 2), CD-I (mode 2, form 1 and form 2), CD-I Ready, CD-I Bridge, CD-R, CD-RW, Photo CD, Video CD, Enhanced Music CD, CD-TEXT</p> <p>Write:</p> <p>DVD: DVD-RAM, DVD-R4.7GB, DVD-RW, DVD+R, DVD+RW</p> <p>CD: CD-R, CD-RW (disc at once, sessionat once, track at once, fixed/variable packet writing, multi-session)</p> |
| Applicable disc format for Pioneer DVR-K15RA | <p>KODAK Photo CD Single and Multi-session</p> <p>CD Extra (CD PLUS)</p> <p>Video CD</p> <p>CD text data (Read / Write)</p> <p>CD-R discs (Read / Write)</p> <p>CD-RW discs (Read / Write)</p> <p>DVD-ROM</p> <p>DVD-R Ver.2.00 for General (Read / Write)</p> <p>DVD-R-DL (Read/Write)</p> <p>DVD-RW Ver.1.0 & 1.1 & 1.2 (Read / Write)</p> <p>DVD+R Ver.1.0 & 1.11& 1.2 (Read/Write)</p> <p>DVD+R -DL Ver1.0 (Read / Write)</p> <p>DVD+RW Ver.1.1 & 1.2 (Read/Write)</p> <p>DVD-RAM (Ver.2.0 & 2.1) (Read only)</p> |
| Applicable disc format for Pioneer DVR-K05RA | <p>KODAK Photo CD Single and Multi-session</p> <p>CD Extra (CD PLUS)</p> <p>Video CD</p> <p>CD text data (Read / Write)</p> <p>CD-R discs (Read / Write)</p> <p>CD-RW discs (Read / Write)</p> <p>DVD-ROM</p> <p>DVD-R Ver.2.00 for General (Read / Write)</p> <p>DVD-RW Ver.1.0 & 1.1 & 1.2 (Read / Write)</p> <p>DVD+R Ver.1.0 & 1.11& 1.2 (Read/Write)</p> <p>DVD+R -DL Ver1.0 (Read / Write)</p> <p>DVD+RW Ver.1.1 & 1.2 (Read/Write)</p> <p>DVD-RAM (Ver.2.0 & 2.1) (Read only)</p> |
| Loading mechanism | <p>Load: Manual (SOSW-833S/DVR-K15)</p> <p>Auto (UJ-845/DVR-K05)</p> <p>Release: (a) Electrical Release (Release Button)</p> <p>(b) Release by ATAPI command</p> <p>(c) Emergency Release (Except for UJ-845/DVR-K05)</p> |
| Power Requirement | |
| Input Voltage | 5 V +/- 5 % (Operating) |

Audio Interface

| Item | Specification |
|---------------------------|--|
| Audio Controller | ALC250 |
| Audio onboard or optional | Built-in |
| Mono or Stereo | Stereo |
| Resolution | 18 bit stereo digital to analog converter 18 bit stereo analog to digital converter |
| Compatibility | AC97 |

Audio Interface

| Item | Specification |
|-----------------------------|--|
| Mixed sound source | Line-in, CD |
| Voice channel | 8/16-bit, mono/stereo |
| Sampling rate | 44,1 KHz (48K byte for AC97 interface) |
| Internal microphone | Yes |
| Internal speaker / Quantity | Yes/2 |

Video Interface

| Item | Specification |
|---------------------------------|--|
| Chipset | ATI Mobility Radeon® X1300 (for discrete models) |
| Package | MBGA 708 pin |
| Interface | PCIE x16 |
| Supports ZV (Zoomed Video) port | Yes |

Video Memory

| Item | Specification |
|-------------|--|
| Chipset | ATI Mobility RADEON® X1300 (for discrete models) |
| Memory size | 64MB/128MB |
| Interface | DDR |

USB Port

| Item | Specification |
|------------------------------|--|
| Chipset | built-in Mobile Intel® 82801FB (ICH6-M) |
| USB Compliancy Level | 2.0 |
| OHCI | USB 1.1 and USB 2.0 Host controller |
| Number of USB port | 3 |
| Location | two on the left side; one on the rear side |
| Serial port function control | Enable/Disable by BIOS Setup |

IEEE 1394 Port (No IEEE Port for this model)

| Item | Specification |
|--------------------------|---------------|
| Chipset | TSB34AB21A |
| Number of IEEE 1394 port | 1 |
| Location | Left side |
| Connector type | IEEE 1394 |

PCMCIA Port

| Item | Specification |
|--------------------|---------------|
| PCMCIA controller | ENE CB712 |
| Supports card type | Type-II |
| Number of slots | One type-II |
| Access location | Left panel |

PCMCIA Port

| Item | Specification |
|---------------------------------|---------------|
| Supports ZV (Zoomed Video) port | No ZV support |
| Supports 32 bit CardBus | Yes |

System Board Major Chips

| Item | Controller |
|-------------------------------|--|
| Core logic | Intel® 915GM/PM+Intel® ICH6-M (Mobile Intel 82801FB) |
| VGA | ATI Mobility RADEON® X1300(for discrete models) |
| LAN | BroadCom BCM4401 |
| IEEE 1394 | TSB34AB21A |
| USB 2.0 | built-in Intel® ICH6-M (Mobile Intel 82801FB) |
| Super I/O controller | SMsC LPC 47N217 |
| Bluetooth | built-in Intel® ICH6-M (Mobile Intel 82801FB) |
| Wireless 802.11 b+g | built-in Intel® ICH6-M (Mobile Intel 82801FB) |
| PCMCIA | ENE CB712 |
| Audio | ALC250 |
| 5-in-1 card reader | ENE CB712 |

Keyboard

| Item | Specification |
|--|--|
| Keyboard controller | KB 910Q |
| Total number of keypads | 84-/85-key |
| Windows logo key | Yes |
| Internal & external keyboard work simultaneously | 1. Plug USB keyboard to the USB port directly: Yes 2. Use port replicator then plug a USB/PS 2 keyboard to the USB port/PS 2 port on the port replicator: Yes |

Battery

| Item | Specification |
|------------------------|---|
| Vendor & model name | BATTERY LI-ION 6 CELLS-SANYO 2000mAH UR18650F BATTERY LI-ION 6 CELLS-SONY 2000mAH US18650G4 BATTERY LI-ION 6 CELLS-SANYO 2400mAH UR18650F BATTERY LI-ION 6 CELLS-SONY 2400mAH US18650G7 BATTERY LI-ION 9 CELLS-SANYO 2400mAH UR18650F |
| Battery Type | Li-ion |
| Pack capacity | 4800mAh 6cell and 7200mAh 9cell for TravelMate 3210 4000mAh 6cell for TravelMate 2400 |
| Number of battery cell | 53.3W 6cell and 79.9W 9cell for TravelMate 3210 44.6W 6cell for TravelMate 2400 |

Battery

| Item | Specification |
|-----------------------|--|
| Package configuration | 3 cells in series, 2 series in parallel for 6-cell battery 2 cells in series, 3 series in parallel for 9-cell battery |
| Normal voltage | 11.1V |
| Charge voltage | 12.6±0.1v |

LCD 14.1 inch

| Item | Specification | | |
|---|--|---|---|
| Vendor & model name | QDI: QD14TL01 (Glare) Surface treatment: glare+hard coating 3H | QDI QD14TL01 | CMO N14111-L03 CMO N14111-L02 (non-glare) |
| Screen Diagonal (mm) | 14.1 inches | 14.1 inches | 14.1 inches |
| Active Area (mm) | 303.7x189.8 | 303.7x189.8 | 303.3x189.6 |
| Display resolution (pixels) | 1280x800 WXGA | 1280x800 WXGA | 1280x800 WXGA |
| Pixel Pitch | 0.2373x0.2373 | 0.2373x0.2373 | 0.2373x0.2373 |
| Pixel Arrangement | R.G.B. Vertical Stripe | R.G.B. Vertical Stripe | R.G.B. Vertical Stripe |
| Display Mode | Normally White | Normally White | Normally White |
| Typical White Luminance (cd/m ²) also called Brightness | 185 | 185 | 185 |
| Luminance Uniformity | 1.25 (5 points) | 1.25 (5 points) | N/A |
| Contrast Ratio | 300 | 300 | 400 |
| Response Time (Optical Rise Time/Fall Time)msec | 10/15 | 10/15 | 5/11 |
| Nominal Input Voltage VDD | +3.3V Typ. | +3.3V | +3.3V |
| Typical Power Consumption (watt) | N/A | N/A | N/A |
| Weight | 440g | 440g | 425g |
| Physical Size(mm) | 320x206x5.5 | 320x206x5.5 | 320x206x5.5 |
| Electrical Interface | 1 channel LVDS | 1 channel LVDS | 1 channel LVDS |
| Support Color | 262K colors (RGB 6-bit data driver) | 262,144 | 262,144 |
| Viewing Angle (degree) Horizontal: Right/Left Vertical: Upper/Lower | 45/45 20/35 | 45/45 20/35 | 45/45 20/45 |
| Temperature Range(° C) Operating Storage (shipping) | 0 to +40 (with high humidity more than 90%RH) -25 to +60 | 0 to +40 (with high humidity more than 90%RH) -25 to +60 | 0 to +40 (with high humidity more than 90%RH) -20 to +60 |

LCD Inverter

| Item | Specification |
|---------------------|--|
| Vendor & model name | Delta DAC-07B037 B YEC YNV-C01 SumidaTWS-442-125 |

LCD Inverter

| Item | Specification |
|---------------------------------|-------------------------|
| Brightness conditions | Vadj=3.3V |
| Input voltage (V) | 9~21 |
| Input current (mA) | 350 (max) |
| Output voltage (V, rms) | 1600 (starting voltage) |
| Output current (mA, rms) | 6.2~6.8 (DAC=0) |
| Output voltage frequency (k Hz) | 45~65K Hz |

AC Adaptor

| Item | Specification |
|--------------------------|----------------------------------|
| Input rating | 90V AC to 264V AC, 47Hz to 63Hz |
| Maximum input AC current | 1.7A |
| Inrush current | 240A@115VAC 240A@230VAC |
| Efficiency | 83% min. @115VAC input full load |

System Power Management

| ACPI mode | Power Management |
|---------------------|--|
| Mech. Off (G3) | All devices in the system are turned off completely. |
| Soft Off (G2/S5) | OS initiated shutdown. All devices in the system are turned off completely. |
| Working (G0/S0) | Individual devices such as the CPU and hard disc may be power managed in this state. |
| Suspend to RAM (S3) | CPU set power down VGA Suspend PCMCIA Suspend Audio Power Down Hard Disk Power Down CD-ROM Power Down Super I/O Low Power mode |
| Save to Disk (S4) | Also called Hibernate state. System saves all system states and data onto the disc prior to power off the whole system. |

System Utilities

BIOS Setup Utility

The BIOS Setup Utility is a hardware configuration program built into your computer's BIOS (Basic Input/Output System).

Your computer is already properly configured and optimized, and you do not need to run this utility. However, if you encounter configuration problems, you may need to run Setup. Please also refer to Chapter 4 Troubleshooting when problem arises.

To activate the BIOS Utility, press **F2** during POST (when "Press <F2> to enter Setup" message is prompted on the bottom of screen).

Press **F2** to enter setup. The default parameter of F12 Boot Menu is set to "disabled". If you want to change boot device without entering BIOS Setup Utility, please set the parameter to "enabled".

Press <F12> during POST to enter multi-boot menu. In this menu, user can change boot device without entering BIOS SETUP Utility.

Navigating the BIOS Utility

There are six menu options: Info., Main, System Devices, Security, Boot, and Exit.

Follow these instructions:

- To choose a menu, use the cursor left/right keys (← →).
- To choose a parameter, use the cursor up/down keys (↑ ↓).
- To change the value of a parameter, press F5 or F6.
- A plus sign (+) indicates the item has sub-items. Press ENTER to expand this item.
- Press ESC while you are in any of the menu options to go to the Exit menu.
- In any menu, you can load default settings by pressing F9. You can also press F10 to save any changes made and exit the BIOS Setup Utility.

Insyde Software SCUMay 20, 2003 5:40:09 AM

MainAdvancedSecurityBootExit

----Devices-----

Product Name = TravelMate 3210

Manufacture Name = Acer

BIOS Version = V1.00

VGA Version = 3104

HDD Model Name = HITACHI_DK23EA-40-(PM)

HDD Serial Number = 123456789

ATAPI Model Name = UJDA740 DVD/CDROM-(SM)

Serial Number = (32 bytes)

Asset Tag = (32 bytes)

UUID = (16 bytes)

----System-----

CPU = Intel® Pentium ® 4

CPU speed = 2.0 GHz

L2 Cache = 2048 KB

----Memory-----

System Memory = 640 KB

Extended Memory = 256MB

VGA Memory = 128 MB

Setup system date, time. Enable boot logo and get system information.

NOTE: You can change the value of a parameter if it is enclosed in square brackets. Navigation keys for a particular menu are shown on the bottom of the screen. Help for parameters are found in the Item Specific Help part of the screen. Read this carefully when making changes to parameter values. **Please note that system information vary in models.**

Main

| | | | | | | |
|---|---|--------------------------------|-------------|-------------|---|---|
| Insyde Software SCU | | May 20, 2005 5:40:09 AM | | | | |
| Main | Advanced | Security | Boot | Exit | | |
| <table border="1" style="width: 100%; border-collapse: collapse;"> <tr> <td style="width: 50%; padding: 5px;"> <pre> -----Devices----- Product Name = TravelMate 3210 Manufacturer Name = Acer BIOS Version = V1.00 VGA Version = 3104 HDD Model Name = HITACHI_DK23EA-40-(PM) HDD Serial Number = 123456789 ATAPI Model Name = UJDA740 DVD/CDROM-(SM) Serial Number = (32 bytes) Asset Tag = (32 bytes) UUID = (16 bytes) </pre> </td> <td style="width: 50%; padding: 5px;"> <pre> -----System----- CPU = Intel® Pentium® 4 CPU speed = 2.0 GHz L2 Cache = 2048 KB -----Memory----- System Memory = 640 KB Extended Memory = 256MB VGA Memory = 128 MB </pre> </td> </tr> </table> <p style="color: blue; margin-top: 10px;">Setup system date, time. Enable boot logo and get system information.</p> | | | | | <pre> -----Devices----- Product Name = TravelMate 3210 Manufacturer Name = Acer BIOS Version = V1.00 VGA Version = 3104 HDD Model Name = HITACHI_DK23EA-40-(PM) HDD Serial Number = 123456789 ATAPI Model Name = UJDA740 DVD/CDROM-(SM) Serial Number = (32 bytes) Asset Tag = (32 bytes) UUID = (16 bytes) </pre> | <pre> -----System----- CPU = Intel® Pentium® 4 CPU speed = 2.0 GHz L2 Cache = 2048 KB -----Memory----- System Memory = 640 KB Extended Memory = 256MB VGA Memory = 128 MB </pre> |
| <pre> -----Devices----- Product Name = TravelMate 3210 Manufacturer Name = Acer BIOS Version = V1.00 VGA Version = 3104 HDD Model Name = HITACHI_DK23EA-40-(PM) HDD Serial Number = 123456789 ATAPI Model Name = UJDA740 DVD/CDROM-(SM) Serial Number = (32 bytes) Asset Tag = (32 bytes) UUID = (16 bytes) </pre> | <pre> -----System----- CPU = Intel® Pentium® 4 CPU speed = 2.0 GHz L2 Cache = 2048 KB -----Memory----- System Memory = 640 KB Extended Memory = 256MB VGA Memory = 128 MB </pre> | | | | | |

NOTE: The system information is subject to different models.

| Parameter | Description |
|-------------------|---|
| Product Name | This field displays the product name of the system. |
| Manufacturer Name | This field displays the manufacturer name of the system |
| BIOS Version | This field displays the BIOS version of the system. |
| VGA Version | This field shows the VGA firmware version of the system. |
| HDD Model Name | This field shows the model name of HDD installed on primary IDE master. |
| HDD Serial Number | This field displays the serial number of HDD installed on primary IDE master. |
| ATAPI Mode Name | This field displays the model name of devices installed on secondary IDE master. The hard disk drive or optical drive model name is automatically detected by the system. |
| Serial Number | This field displays the serial number of this unit. |
| Asset Tag | This field displays the asset tag of this unit. |
| UUID | This will be visible only when an internal LAN device is presenting. UUID=32bytes |
| CPU | This field shows the brand name of the system CPU. |
| CPU speed | |

| Parameter | Description |
|-----------------|--|
| L2 Cache | This field displays CPU L2 cache size. It varies in CPU type. |
| System Memory | This field reports the memory size of system base memory. The size is fixed to 640 KB. |
| Extended Memory | This field reports the memory size of the extended memory in the system. Extended memory size = Total memory size - 2MB |
| VGA Memory | <p>VGA Memory size:</p> <p>Discrete = 64 or 128MB (depends on actual VRAM size)</p> <p>TurboCache = 32MB (actual TurboCache VRAM size)</p> <p>Intel(R) 915 DVMT: you can select the following options:</p> <ol style="list-style-type: none"> 64MB (8MB pre-allocated + 56MB DVMT) 128MB (8MB pre-allocated + 128MB DVMT)-Default value Max DVMT (160MB on 256MB system memory, 224MB on 512 and above system memory). |

The Main screen displays a summary of your computer hardware information, and also includes basic setup parameters. It allows the user to specify standard IBM PC AT system parameters.

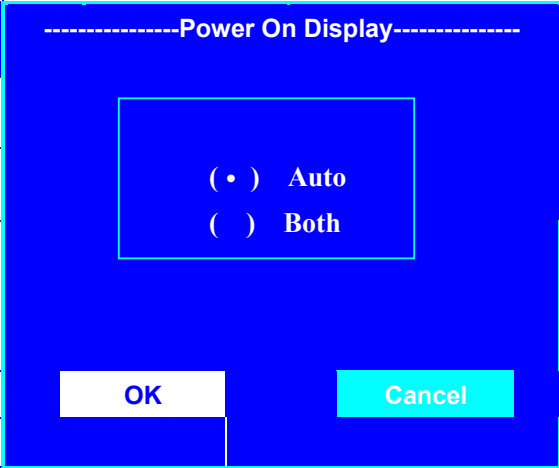
| Insyde Software SCU | | May 20, 2005 5:40:09 AM | | |
|---|--|-------------------------|------|------|
| Main | Advanced | Security | Boot | Exit |
| Date and Time |  | | | |
| Power On Display | | | | |
| ∨ Quiet Boot | | | | |
| ∨ LCD Auto DIM | | | | |
| ∨ Network Boot | | | | |
| _ F12 Boot Menu | | | | |
| ∨ D2D Recovery | | | | |
| Press <Tab> key to select a control. <OK> button or <Enter> key accept entries. <Cancel> button or <Esc> key reject entries. Use cursor, spacebar, and numeric keys to change values. <Alt> key activates accelerators. | | | | |

NOTE: The screen above is for your reference only. Actual values may differ.

The table below describes the parameters in this screen. Settings in **boldface** are the default and suggested parameter settings.

| Parameter | Description | Format/Option |
|------------------|--|------------------------------------|
| Date and Time | The hours are displayed with 12 hour format. The values set in these two fields take effect immediately. | |
| Quiet Boot | Determines if the system will display customer logo and summary screen or not. Enable: Customer logo is displayed, and summary screen is disabled. Disabled: Customer logo is not displayed, and summary screen is enabled. | Option: Enabled or Disabled |
| Power on display | Auto: During power process, the system will detect if any display device is connected on external video port. If any external display device is connected, the power on display will be in CRT (or projector) only mode. Otherwise it will be in LCD only mode. Both: Simultaneously enable both the integrated LCD screen and the system's external video port (for an external CRT or projector). | Option: Auto or Both |
| LCD Auto Dim | Determines if the system will automatically dim the LCD brightness in order to save power when AC is not present. The system will support an automatic dimming of the LCD backlight when the AC power is NOT available (running on battery power). | Option: Enabled or Disabled |
| Network Boot | Enables, disables the system boot from LAN (remote server). | Option: Enabled or Disabled |
| F12 Boot Menu | Enables, disables Boot Menu during POST. | Option: Disabled or Enabled |
| D2D Recovery | Enables, disables D2D Recovery function. The function allows the user to create a hidden partition on hard disc drive to store operation system and restore the system to factory defaults. | Option: Enabled or Disabled |

NOTE: You can also enable Acer disc-to-disc system recovery via Alt+F10 during POST.

Advanced

The Advanced menu screen contains parameters involving your hardware devices. It also provides advanced settings of the system.

Insyde Software SCU May 20, 2005 5:40:09 AM

Main **Advanced** Security Boot Exit

Infrared Port (FIR)

Max. Graphics Memory

▼ Legacy USB Support

-----Infrared Port(FIR)-----

-----FIR I/O settings---

Disabled

Enabled

-Mode Setting for IRDA-

Normal (16550)

IrDA (HPSIR)

ASK IR

FAST IR

DMA Setting For FIR

DMA1

DMA2

DMA3

OK Cancel

<Tab> <Right> <Left> for block select. <Up> <Down> for item select.
 <Enter> for accept. <Cancel> <Esc> for reject. <Alt> activates accelerators.
 <Space> for Enable or Disable.

The table below describes the parameters in the screen. Settings in **boldface** are the default and suggested parameter settings.

| Parameter | Description | Options |
|---------------------|--|--------------------------|
| Infrared Port | Enables or disables the infrared port. | Disabled /Enabled |
| Max Graphics Memory | This option is only available on Intel (R) 915 UMA system. | 64MB/ 128MB /DVMT |
| Legacy USB support | This feature allows you to USB keyboard entering BIOS Setup. This feature also allows you to use a USB keyboard in DOS without additional driver. USB floppy boot and Crisis Recovery from USB floppy is also supported. | Enabled /Disabled |

Security

The Security screen contains parameters that help safeguard and protect your computer from unauthorized use.

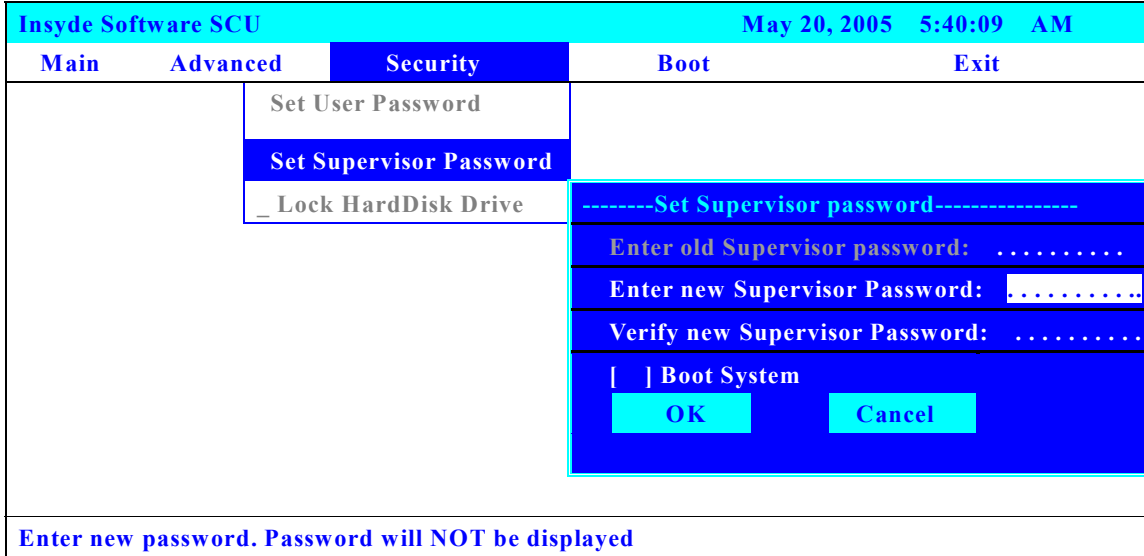

The table below describes the parameters in this screen. Settings in **boldface** are the default and suggested parameter settings.

Set Supervisor/User Password

If password on boot is required, the password must be set otherwise it cannot be enabled.

The formats of the password are as follows:

Length 10 characters

Characters Alphanumeric keys only. The shift status i.e. Ctrl, Shift, Alt and Capital are ignored.

| Parameter | Description | Option |
|-------------------------|--|----------------------------|
| Set User Password | Press Enter to set the user password. When set, this password protects the BIOS Setup Utility from unauthorized access. | |
| Set Supervisor Password | Press Enter to set the administrator password. When set, this password protects the BIOS Setup Utility from unauthorized access. | |
| Lock HardDisk Drive | Allows the user to specify whether or not a password is required to access hard disk drive. | Disabled or Enabled |

NOTE: When you are prompted to enter a password, you have three tries before the system halts. Don't forget your password. If you forget your password, you may have to return your notebook computer to your dealer to reset it.

Boot

This menu allows the user to decide the order of boot devices to load the operating system. Bootable devices includes the distette drive in module bay, the onboard hard disk drive and the CD-ROM in module bay.

| Insyde Software SCU | | | May 20, 2005 5:40:09 | | | | | | |
|--|----------|----------|----------------------|------|-------------------------|------------|------------------|---------------|--------------|
| Main | Advanced | Security | Boot | Exit | | | | | |
| | | | Boot Device | | | | | | |
| <table border="1"><tr><td>----- Boot Device -----</td></tr><tr><td>Hard Drive</td></tr><tr><td>CD-ROM/DVD Drive</td></tr><tr><td>Floppy Device</td></tr><tr><td>Network Boot</td></tr></table> | | | | | ----- Boot Device ----- | Hard Drive | CD-ROM/DVD Drive | Floppy Device | Network Boot |
| ----- Boot Device ----- | | | | | | | | | |
| Hard Drive | | | | | | | | | |
| CD-ROM/DVD Drive | | | | | | | | | |
| Floppy Device | | | | | | | | | |
| Network Boot | | | | | | | | | |
| <p>Press <Tab> key to select a control. <OK> button or <Enter> key accept entries. <Cancel> button or <ESC> key reject entries. Use spacebar and number keys to change value <Alt> key activates accelerators.</p> | | | | | | | | | |

Exit

The Exit screen contains parameters that help safeguard and protect your computer from unauthorized use.

| | | | | | |
|---|-----------------|-----------------|-------------|--------------------------------|--|
| Insyde Software SCU | | | | Nov 26, 2005 5:40:09 | |
| Main | Advanced | Security | Boot | Exit | |
| | | | | Exit Saving Changes | |
| | | | | Exit Discarding Changes | |
| | | | | Load Setup Defaults | |
| | | | | Discard Changes | |
| <div style="border: 2px solid cyan; padding: 10px; text-align: center;"> <p>-----Exit Saving Changes-----</p> <p>Press <OK> to save the current Setup parameters to CMOS RAM.</p> <p>The system will reboot!!!</p> <div style="display: flex; justify-content: space-around; margin-top: 10px;"> <div style="border: 1px solid black; padding: 5px 15px; background-color: white;">OK</div> <div style="border: 1px solid black; padding: 5px 15px; background-color: cyan;">Cancel</div> </div> </div> | | | | | |
| <p><Tab> <Right> <Left> for block select. <Up> <Down> for item select. <Enter> for accept. <Cancel> <Esc> for reject. <Alt> activates accelerators. <Space> for Enable or Disable.</p> | | | | | |

The table below describes the parameters in this screen.

| Parameter | Description |
|-------------------------|---|
| Exit Saving Changes | Exit System Setup and save your changes to CMOS. |
| Exit Discarding Changes | Exit utility without saving setup data to CMOS. |
| Load Setup Default | Load default values for all SETUP item. |
| Discard Changes | Load previous values from CMOS for all SETUP items. |

BIOS Flash Utility

The BIOS flash memory update is required for the following conditions:

- New versions of system programs
- New features or options
- Restore a BIOS when it becomes corrupted.

Use the Phlash utility to update the system BIOS flash ROM.

NOTE: If you do not have a crisis recovery diskette at hand, then you should create a **Crisis Recovery Diskette** before you use the Phlash utility.

NOTE: Do not install memory-related drivers (XMS, EMS, DPMS) when you use the Phlash.

NOTE: Please use the AC adaptor power supply when you run the Phlash utility. If the battery pack does not contain enough power to finish BIOS flash, you may not boot the system because the BIOS is not completely loaded.

Follow the steps below to run the Phlash.

1. Prepare a bootable diskette.
2. Copy the Phlash utilities to the bootable diskette.
3. Then boot the system from the bootable diskette. The Phlash utility has auto-execution function.

Machine Disassembly and Replacement

This chapter contains step-by-step procedures on how to disassemble the notebook computer for maintenance and troubleshooting.

To disassemble the computer, you need the following tools:

- Wrist grounding strap and conductive mat for preventing electrostatic discharge
- Small Philips screw driver
- Philips screwdriver
- Plastic flat head screw driver
- Tweezers

NOTE: The screws for the different components vary in size. During the disassembly process, group the screws with the corresponding components to avoid mismatch when putting back the components. When you remove the stripe cover, please be careful not to scrape the cover.

General Information

Before You Begin

Before proceeding with the disassembly procedure, make sure that you do the following:

1. Turn off the power to the system and all peripherals.
2. Unplug the AC adapter and all power and signal cables from the system.
3. Remove the battery pack.

Disassembly Procedure Flowchart

The flowchart on the succeeding page gives you a graphic representation on the entire disassembly sequence and instructs you on the components that need to be removed during servicing. For example, if you want to remove the system board, you must first remove the keyboard, then disassemble the inside assembly frame in that order.

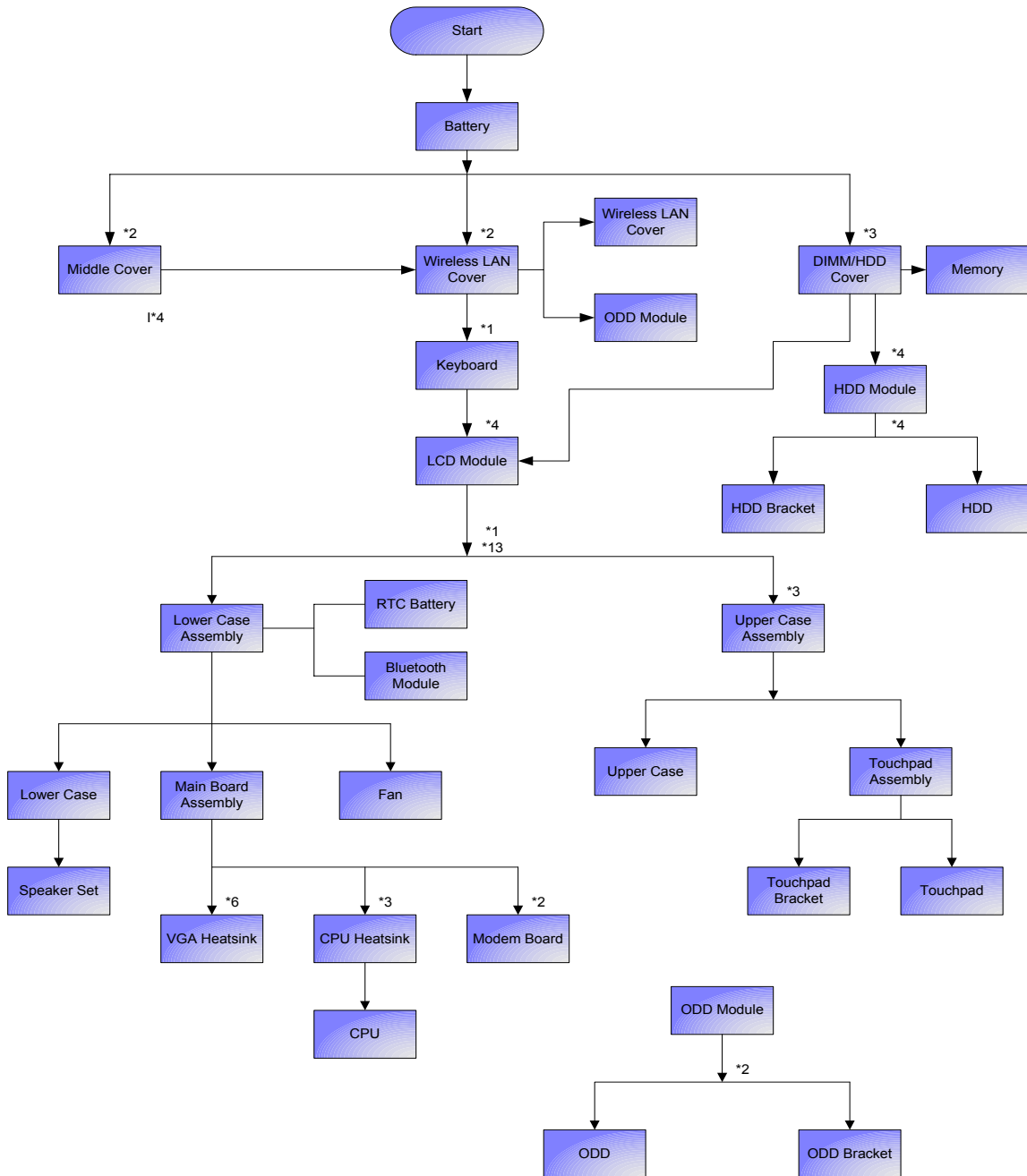

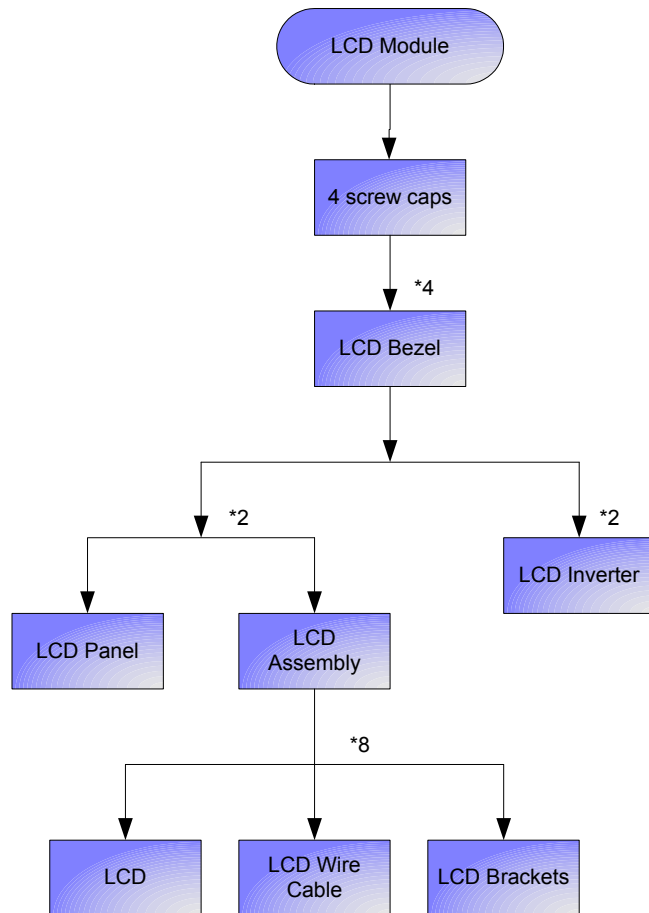

Screw List

| Item | Description |
|------|--------------------------------|
| A | SCW HEX NYL I#R-40/O#4-40 L5.5 |
| B | SCREW MACH WAFER M2*L4 NI |
| C | CPU SCREW M2.5*6.5 (2.7KG) |
| D | CPU SCREW M2.5*6.5 (4.5KG) |
| E | SCRW WH MS+CBZ M2.5+L4 BLACK |
| F | SCREW M2.5-6 |
| G | SCREW M2*3 NYLON 1JMCPC-420325 |
| H | SCREW M2.5X6 |
| I | SCREW M2-3 |
| J | SCRW M2.5*L3(NON NYLOK) |
| K | SCREW M2.5-5 |
| L | SCREW M3x4(86.9A524.4R0) |
| M | SCREW WAFER NYLOK NI 2ML3 |
| N | SCREW NI M2*6L |

Removing the Battery Pack

1. Unlock the battery lock.
2. Slide the battery latch then remove the battery.



Removing the Wireless LAN Card/the HDD Module/the Memory/the CPU/ the ODD Module and the LCD Module

Removing the Wireless LAN Card and the HDD Module

1. Remove the two screws fastening the PCI door.
2. Detach the PCI door.



3. Disconnect the wireless antennae.
4. Pop out the wireless LAN card then remove it.



5. Remove the two screws fastening the HDD cover.
6. Remove HDD cover carefully.
7. Pull the HDD module backwards to disconnect the HDD module then remove it from the main unit.

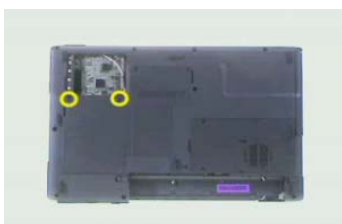

Removing the Memory and the CPU

1. Remove the two screws fastening DIMM cover.
2. Then detach the DIMM cover.
3. Pop out the memory then remove it from the DIMM socket.



4. Remove the two screws fastening the thermal door.
5. Detach the thermal door from the main unit.



6. Remove the four screws holding the thermal module. (Follow the order indicated by the numbers: 4, 3, 2 then 1. Please reverse the order when you assemble the system).
7. Disconnect the fan cable as shown.
8. Take out the thermal module from the main unit carefully.



9. Use a flat headed screwdriver to release the CPU lock.
10. Then remove the CPU from the CPU socket carefully.



Removing the ODD Module and the LCD module

1. Remove the screws fastening the ODD module as shown.
2. Use a flat headed screwdriver to push the ODD module outwards then remove it.



3. Open the LCD module as shown and detach the middle cover carefully.
4. Remove the two screws fastening the keyboard.



5. Turn over the keyboard as shown.
6. Disconnect the keyboard cable then remove the keyboard.

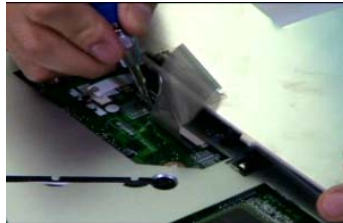

7. Tear off the mylar festening the wireless antenna set.
8. Pull out the wireless antenna from the main unit carefully.
9. Disconnect the LCD cable from the main board.



10. Remove two screws holding the LCD module.
11. Remove another two screws fastening the LCD module on the bottom.
12. Then detach the LCD module from the main unit carefully.



Disassembling the Main Unit

Separate the Main Unit Into the Upper and the Lower Case Assembly

1. To separate the upper and the lower case assembly, remove six screws as shown.
2. Turn over the main unit, remove 9 screws on the other side.
3. Separate the main unit into the upper case assembly and the lower case assembly.

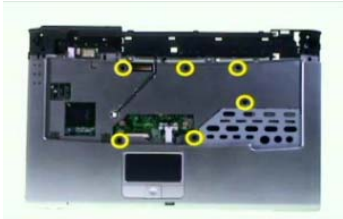

Disassembling the Upper Case Assembly

1. Disconnect the touchpad FFC from the main board.
2. Disconnect the bluetooth cable.
3. Detach the bluetooth module from the upper case.



4. Disconnect the bluetooth cable from the bluetooth card.
5. Disconnect the touchpad to touchpad board FFC.
6. Remove the three screws fastening the touchpad board.

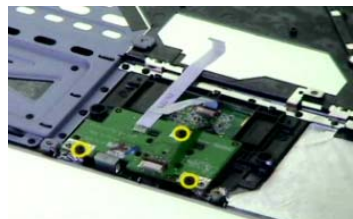
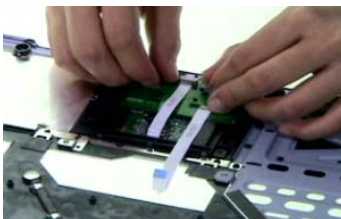

7. Detach the touchpad board.
8. Remove the four-way button from the upper case.
9. Remove the two screws fastening the touchpad support to the upper case.

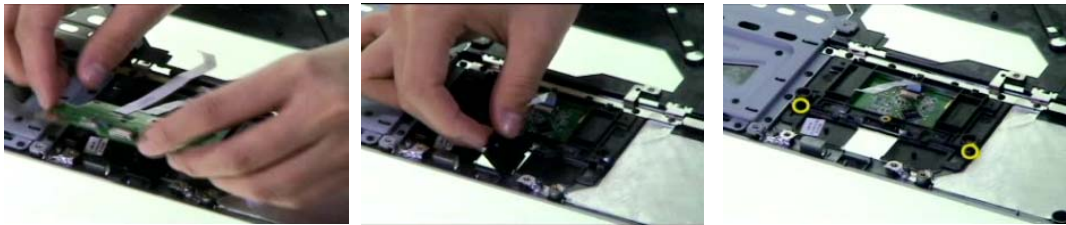

10. Detach the touchpad support from the upper case carefully.
11. Detach the touchpad from the upper case.
12. Disconnect the FFC from the touchpad.



Disassembling the Lower Case Assembly

1. Remove four screws fastening the main board to the lower case.
2. Turn over the lower case assembly, then remove one screw on the other side as shown.

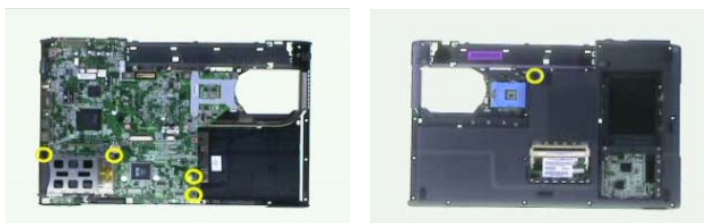

3. Disconnect the speaker cable.
4. Detach the main board assembly from the lower case carefully.
5. Remove the three screws fastening the VGA board.



6. Disconnect the VGA board assembly from the main board.
7. Remove the three screws fastening the VGA thermal to the VGA board. Detach the main board assembly from the lower case carefully. (Follow the order indicated by the numbers: 3, 2 then 1. Please reverse the order when you assemble the system).

8. Detach the VGA thermal from the VGA board.

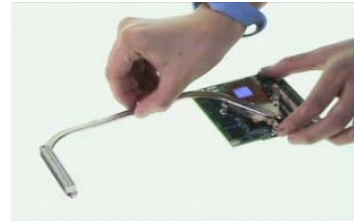
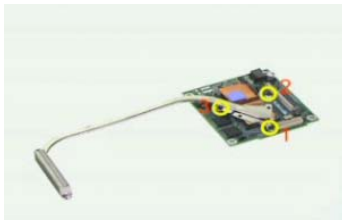
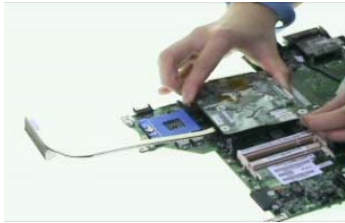

9. Disconnect the modem cable from the main board.
10. Remove the two screws fastening the modem board as shown.
11. Disconnect the modem board from the main board.



12. Disconnect the modem cable from the modem board.
13. Remove the two screws holding the speaker set to the lower case.
14. Take out the speaker set from the lower case. This completes the main unit disassembly.

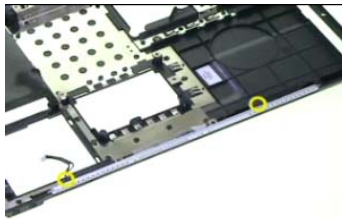
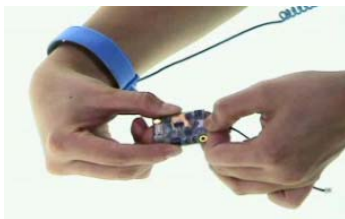

Disassembling the LCD Module

1. Remove the four screw caps as shown.
2. Remove the four screws holding the LCD bezel.
3. Then detach the LCD bezel from the LCD module.



4. Remove the screw fastening the LCD inverter.
5. Disconnect the LCD cable and disconnect the inverter cable, then remove the inverter.
6. Remove the two screws fastening the LCD assembly to the LCD panel.

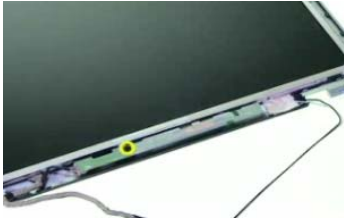

7. Take out the LCD assembly from the LCD panel.
8. Remove the four screws fastening the LCD left bracket then remove it.
9. Remove the four screws fastening the LCD right bracket.

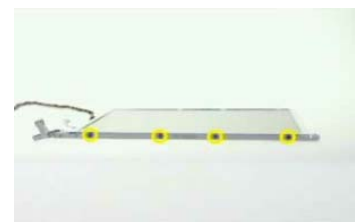
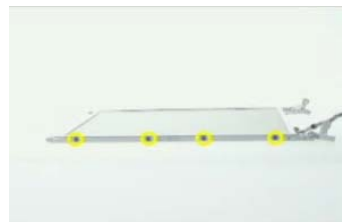

10. Then remove the LCD right bracket.
11. Tear off the mylar and disconnect the LCD cable from the LCD then remove the cable.

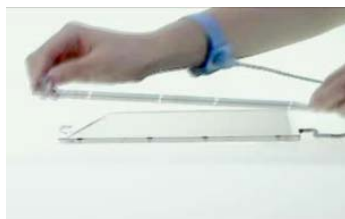

Disassembling the External Modules

Disassembling the HDD Module

1. Remove the two screws holding the HDD bracket on one side.
2. Remove another two screws holding the HDD bracket on the other side.
3. Then take the hard disc drive out of the HDD bracket.



Disassembling the ODD Module

1. Remove the two screws fastening the ODD bracket.
2. Remove the ODD bracket from the optical disc drive module.



Troubleshooting

Use the following procedure as a guide for computer problems.

NOTE: The diagnostic tests are intended to test this model. Non-Acer products, prototype cards, or modified options can give false errors and invalid system responses.

1. Duplicate symptom and obtain the failing symptoms in as much detail as possible.
2. Distinguish symptom. Verify the symptoms by attempting to re-create the failure by running the diagnostic test or by repeating the same operation.
3. Disassemble and assemble the unit without any power sources.
4. If any problem occurs, you can perform visual inspection before you follow this chapter's instructions. You can check the following:
 - power cords are properly connected and secured;
 - there are no obvious shorts or opens;
 - there are no obviously burned or heated components;
 - all components appear normal.
5. Use the following table with the verified symptom to determine which page to go to.

| Symptoms (Verified) | Go To |
|---|---|
| Power failure. (The power indicator does not go on or stay on.) | "Power System Check" on page 59. |
| POST does not complete. No beep or error codes are indicated. | "Power-On Self-Test (POST) Error Message" on page 61 "Undetermined Problems" on page 71 |
| POST detects an error and displayed messages on screen. | "Error Message List" on page 62 |
| Other symptoms (i.e. LCD display problems or others). | "Power-On Self-Test (POST) Error Message" on page 61 |
| Symptoms cannot be re-created (intermittent problems). | Use the customer-reported symptoms and go to "Power-On Self-Test (POST) Error Message" on page 61 "Intermittent Problems" on page 70 "Undetermined Problems" on page 71 |

System Check Procedures

External Diskette Drive Check

If an error occurs with the internal diskette drive, reconnect the diskette connector on the system board.

If the error still remains:

1. Reconnect the external diskette drive/DVD-ROM module.
2. Replace the external diskette drive/CD-ROM module.
3. Replace the main board.

External CD-ROM Drive Check

Do the following to isolate the problem to a controller, drive, or CD-ROM. Make sure that the CD-ROM does not have any label attached to it. The label can cause damage to the drive or can cause the drive to fail.

Do the following to select the test device:

1. Boot from the diagnostics diskette and start the diagnostics program.
2. See if CD-ROM Test is passed when the program runs to CD-ROM Test.
3. Follow the instructions in the message window.

If an error occurs, reconnect the connector on the System board. If the error still remains:

1. Reconnect the external diskette drive/CD-ROM module.
2. Replace the external diskette drive/CD-ROM module.
3. Replace the main board.

Keyboard or Auxiliary Input Device Check

Remove the external keyboard if the internal keyboard is to be tested.

If the internal keyboard does not work or an unexpected character appears, make sure that the flexible cable extending from the keyboard is correctly seated in the connector on the system board.

If the keyboard cable connection is correct, run the Keyboard Test.

If the tests detect a keyboard problem, do the following one at a time to correct the problem. Do not replace a non-defective FRU:

1. Reconnect the keyboard cables.
2. Replace the keyboard.
3. Replace the main board.

The following auxiliary input devices are supported by this computer:

- Numeric keypad
- External keyboard

If any of these devices do not work, reconnect the cable connector and repeat the failing operation.

Memory check

Memory errors might stop system operations, show error messages on the screen, or hang the system.

1. Boot from the diagnostics diskette and start the doagmpstotics program (please refer to main board).
2. Go to the diagnostic memory in the test items.
3. Press F2 in the test items.
4. Follow the instructions in the message window.

NOTE: Make sure that the DIMM is fully installed into the connector. A loose connection can cause an error.

Power System Check

To verify the symptom of the problem, power on the computer using each of the following power sources:

1. Remove the battery pack.
2. Connect the power adapter and check that power is supplied.
3. Disconnect the power adapter and install the charged battery pack; then check that power is supplied by the battery pack.

If you suspect a power problem, see the appropriate power supply check in the following list:

- “Check the Battery Pack” on page 60

Check the Battery Pack

To check the battery pack, do the following:

From Software:

1. Check out the Power Management in control Panel
2. In Power Meter, confirm that if the parameters shown in the screen for Current Power Source and Total Battery Power Remaining are correct.
3. Repeat the steps 1 and 2, for both battery and adapter.
4. This helps you identify first the problem is on recharging or discharging.

From Hardware:

1. Power off the computer.
2. Remove the battery pack and measure the voltage between battery terminals 1(+) and 6(ground). See the following figure
3. If the voltage is still less than 7.5 Vdc after recharging, replace the battery.

To check the battery charge operation, use a discharged battery pack or a battery pack that has less than 50% of the total power remaining when installed in the computer.

If the battery status indicator does not light up, remove the battery pack and let it return to room temperature. Re-install the battery pack.

If the charge indicator still does not light up, replace the battery pack. If the charge indicator still does not light up, replace the DC/DC charger board.

Touchpad check

If the touchpad doesn't work, do the following actions one at a time to correct the problem. Do not replace a non-defective FRU:

1. After rebooting, run Tracking Pad PS2 Mode Driver. For example, run Syn touch driver.
2. Run utility with the PS/2 mouse function and check if the mouse is working.
3. If the the PS/2 mouse does not work, then check if the main board to switch board FPC is connected O.K.
4. If the main board to switch board FPC is connected well, then check if the FCC on touch pad PCB connects properly.
5. If the FFC on touch pad PCB connects properly, then check if LS851 JP1 Pin6=5V are pulese. If yes, then replace switch board. If no, then go to next step.
6. Replace touch pad PCB.
7. If the touch pad still does not work, then replace FPC on Track Pad PCB.

After you use the touchpad, the pointer drifts on the screen for a short time. This self-acting pointer movement can occur when a slight, steady pressure is applied to the touchpad pointer. This symptom is not a hardware problem. No service actions are necessary if the pointer movement stops in a short period of time.

Power-On Self-Test (POST) Error Message

The POST error message index lists the error message and their possible causes. The most likely cause is listed first.

NOTE: Perform the FRU replacement or actions in the sequence shown in FRU/Action column, if the FRU replacement does not solve the problem, put the original part back in the computer. Do not replace a non-defective FRU.

This index can also help you determine the next possible FRU to be replaced when servicing a computer.

If the symptom is not listed, see “Undetermined Problems” on page 71.

The following lists the error messages that the BIOS displays on the screen and the error symptoms classified by function.

NOTE: Most of the error messages occur during POST. Some of them display information about a hardware device, e.g., the amount of memory installed. Others may indicate a problem with a device, such as the way it has been configured.

NOTE: If the system fails after you make changes in the BIOS Setup Utility menus, reset the computer, enter Setup and install Setup defaults or correct the error.

Index of Error Messages

Error Message List

| Error Messages | FRU/Action in Sequence |
|---|--|
| Struck Key | See "Keyboard or Auxiliary Input Device Check" on page 58 |
| System CMOS checksum bad - Default configuration used | RTC battery Run BIOS Setup Utility to reconfigure system, then reboot system. |
| Real time clock error | RTC battery Run BIOS Setup Utility to reconfigure system time, then reboot system. Main board |
| Previous boot incomplete - Default configuration used | "Load Default Settings" in BIOS Setup Utility. RTC battery Main board |
| Invalid System Configuration Data | "Load Default Settings" in BIOS Setup Utility. Main board |
| Operating system not found | Enter Setup and see if fixed disk and drive A are properly identified. Dikette drive Hard disk drive Main board |

Error Message List

| No beep Error Messages | FRU/Action in Sequence |
|--|--|
| Power-on indicator turns off and LCD is blank. | Power source (battery pack and power adapter.) See "Power System Check" on page 59 Ensure every connector is connected tightly and correctly. Reconnect the DIMM. Main board. |
| Power-on indicator turns on and LCD is blank. | Power source (battery pack and power adapter.) See "Power System Check" on page 59 Reconnect the LCD connector Hard disk drive LCD cable LCD inverter LCD Main board |
| Power-on indicator turns on and LCD is blank. But you can see POST on an external CRT. | Reconnect the LCD connectors. LCD cable LCD inverter LCD Main board |
| Power-on indicator turns on and a blinking cursor shown on LCD during POST. | Ensure every connector is connected tightly and correctly. Main board |

Insyde MobilePro BIOS POST Beep Code and POST Messages

The POST error message index lists the error message and their possible causes. The most likely cause is listed first.

NOTE: Perform the FRU replacement or actions in the sequence shown in FRU/Action column, if the FRU replacement does not solve the problem, put the original part back in the computer. Do not replace a non-defective FRU.

This index can also help you determine the next possible FRU to be replaced when servicing a computer.

If the symptom is not listed, see “Undetermined Problems” on page 71.

The following lists the error messages that the BIOS displays on the screen and the error symptoms classified by function.

NOTE: Most of the error messages occur during POST. Some of them display information about a hardware device, e.g., the amount of memory installed. Others may indicate a problem with a device, such as the way it has been configured.

NOTE: If the system fails after you make changes in the BIOS Setup Utility menus, reset the computer, enter Setup and install Setup defaults or correct the error.

| Beep Code | Message | Description |
|---|---|---|
| short, short, short; short, short, long | “FAULTY DMA PAGE REGISTERS” | DMA page registers do not function properly. |
| short, short, short; short, long, short | “FAULTY REFRESH CIRCUIT” | RAM refresh circuit does not function properly. |
| short, short, short; short, long, long | “ROM CHECKSUM INCORRECT” | BIOS ROM checksum failed. |
| short, short, short; long, short, short | “CMOS RAM TEST FAILED” | CMOS RAM test failed. |
| short, short, short; long, short, long | “DMA CONTROLLER FAULTY” | DMA controller does not work properly. |
| short, short, short; long, long short | “INTERRUPT CONTROLLER FAILED” | The interrupt controller does not work properly. |
| short, short, short; long, long, long | N/A | Keyboard controller failed to respond with the self-test command. |
| short, short, long; short, short, short | N/A | No video device found. |
| short, short, long; short, short, long | N/A | No RAM installed. |
| N/A | “KEYBOARD CONTROLLER FAILURE” | Keyboard controller failed during system inquiry about connected devices. |
| N/A | “KEYBOARD FAILURE” | The keyboard fails to respond or no keyboard is connected. |
| N/A | “CMOS FAILURE - RUN SCU” | CMOS data error, probably due to battery power loss. |
| N/A | “CMOS CHECKSUM INVALID - RUN SCU” | CMOS checksum error. |
| N/A | “RAM ERROR AT LOCATION xxxxxx: WROTE: xxxx READ: xxxx” | The RAM failed during memory test at the indicated location. |
| N/A | “PARITY ERROR AT UNKNOWN LOCATION” | Parity error during memory test at unknown location. |
| N/A | “PARITY ERROR AT LOCATION XXXXXX” | Parity error during memory test at the indicated location. |

| Beep Code | Message | Description |
|-----------|--|--|
| N/A | "NO INTERRUPTS FROM TIMER 0" | Timer 0 of the clock timer controller does not generate system interrupts correctly. |
| N/A | "UNEXPECTED AMOUNT OF MEMORY - RUN SCU" | The system memory size does not match with the CMOS record. |
| N/A | "CLOCK NOT TICKING CORRECTLY" | The system clock does not working correctly. |
| N/A | "TIME/DATA CORRUPT - RUN SCU" | The time/date information in CMOS is invalid. |
| N/A | "MACHINE IS LOCKED - TURN KEY" | The keyboard operation is locked. |
| N/A | "BOOT SECTOR 0 HAS CHANGED" | The boot sector of the hard disk has been changed, probably because of a virus attack. |
| N/A | Suspend-to-Disk partition MISSING!" | No Suspend-to-Disk partition found. |
| N/A | "Hard Disk ERROR!" | Access to the Suspend-to-Disk partition failed. |
| N/A | "Suspend-to-Disk partition signature NOT FOUND!" | No Suspend-to-Disk partition signature found. |
| N/A | "Suspend-to-Disk partition size TOO SMALL!" | The capacity of the Suspend-to-Disk partition is not enough. |
| N/A | "MEMORY SIZE HAS CHANGED -- REBOOTING" | The memory size has changed after previous Suspend-to-Disk operation. |

Index of Symptom-to-FRU Error Message

LCD-Related Symptoms

| Symptom / Error | Action in Sequence |
|--|--|
| LCD backlight doesn't work | First, plug a monitor to CRT port. Next, enter BIOS utility to running "Load Default Settings" then reboot the system. Reconnect the LCD connectors. Keyboard (if the brightness function key doesn't work). LCD cable LCD inverter LCD Main board |
| LCD is too dark LCD brightness cannot be adjusted | Enter BIOS Utility to execute "Load Setup Default Settings", then reboot system. Reconnect the LCD connectors. Keyboard (if the brightness function key doesn't work). LCD cable LCD inverter LCD Main board |
| Unreadable LCD screen Missing pels in characters Abnormal screen Wrong color displayed LCD has extra horizontal or vertical lines displayed. | Reconnect the LCD cable LCD cable LCD Main board |

Indicator-Related Symptoms

| Symptom / Error | Action in Sequence |
|--|---|
| Indicator incorrectly remains off or on, but system runs correctly | Main board |
| HDD/CD-ROM active indicators cannot work | HDD/CD-ROM drive Device driver Main board |

Power-Related Symptoms

| Symptom / Error | Action in Sequence |
|-----------------------------------|--|
| Power shuts down during operation | Power source (battery pack and power adapter). See "Power System Check" on page 59. Battery pack AC adapter See if the thermal module is overheat (Heat sink or fan). Main board |
| The system cannot power-on. | Power source (battery pack and power adapter). See "Power System Check" on page 59. Battery pack Power adapter CPU Main board |
| The system cannot power-off. | In Windows XP operating system, hold and press the power switch for more than 4 seconds. If the system can power off, then the main board is OK. Verify OS in the HDD. Main board |

Power-Related Symptoms

| Symptom / Error | Action in Sequence |
|--|--|
| Battery can't be charged or discharged | See "Check the Battery Pack" on page 60. Battery pack Main board |
| System hang during POST | ODD/HDD/FDD/RAM module Main board |

PCMCIA-Related Symptoms

| Symptom / Error | Action in Sequence |
|---|---|
| System cannot detect the PC Card (PCMCIA) | PCMCIA slot assembly Main board |
| PCMCIA slot pin is damaged. | PCMCIA slot assembly |
| PC Card cannot be inserted or ejected | Check if the PCMCIA slot is blocked Main board |

Memory-Related Symptoms

| Symptom / Error | Action in Sequence |
|--|--|
| Memory count (size) appears different from actual size. | Enter BIOS Setup Utility to execute "Load Default Settings" then reboot system. RAM module Main board Check BIOS revision |
| System can power on, but you hear two long beeps: "B--, B--" and the LCD is blank. | Reinsert DIMM DIMM Main board |

Speaker-Related Symptoms

| Symptom / Error | Action in Sequence |
|--|--|
| In Windows, multimedia programs, no sound comes from the computer. | OS volume control Audio driver Speaker Main board |
| Internal speakers make noise or emit no sound. | Speaker Main board |
| Microphone cannot work | Audio driver Volume control in Windows XP Main board |

Power Management-Related Symptoms

| Symptom / Error | Action in Sequence |
|---|---|
| The system will not enter hibernation mode | Power option in Windows XP Hard disk drive Main board |
| The system doesn't enter standby mode after closing the lid of the portable computer. | Driver of Power Option Properties Lid close switch in upper case Main board |

Power Management-Related Symptoms

| Symptom / Error | Action in Sequence |
|---|---|
| The system doesn't resume from hibernation/standby mode. | Connect AC adapter then check if the system resumes from Standby/Hibernation mode. Check if the battery is low. Hard disk drive Main board |
| The system doesn't resume from standby mode after opening the lid of the portable computer. | LCD cover switch Main board |
| Battery fuel gauge in Windows doesn't go higher than 90%. | Refresh battery (continue use battery until power off, then charge battery). Battery pack Main board |
| System hangs intermittently. | Reconnect hard disk/CD-ROM drives. Main board |

Peripheral-Related Symptoms

| Symptom / Error | Action in Sequence |
|--|---|
| System configuration does not match the installed devices. | Enter BIOS Setup Utility to execute "Load Setup defaults", then reboot system. Reconnect hard disk/CD-ROM drives/FDD or other peripherals. Main board |
| External display does not work correctly. | Press Fn+F5, LCD/CRT/Both display switching Keyboard Main board |
| USB does not work correctly | Main board |
| Print problems. | Enter BIOS Setup Utility to execute "Load Default Settings" then reboot the system. Run printer self-test. Printer driver Printer cable Printer Main board |
| Parallel port device problems | Enter BIOS Setup Utility to execute "Load Default Settings" then reboot the system. Device driver Device cable Device Main board |

Keyboard/Touchpad-Related Symptoms

| Symptom / Error | Action in Sequence |
|--|---|
| Keyboard (one or more keys) does not work. | Reconnect the keyboard cable. Keyboard Main board |
| Touchpad does not work. | Reconnect touchpad cable. Touchpad board Main board |

Modem/LAN-Related Symptoms

| Symptom / Error | Action in Sequence |
|---|--|
| Internal modem does not work correctly. | Phone cable Driver Reconnect the Internal modem cable to the main board tightly. Main board |
| Internal LAN does not work correctly | Lan cable Driver Main board |

NOTE: If you cannot find a symptom or an error in this list and the problem remains, see “Undetermined Problems” on page 71.

Intermittent Problems

Intermittent system hang problems can be caused by a variety of reasons that have nothing to do with a hardware defect, such as: cosmic radiation, electrostatic discharge, or software errors. FRU replacement should be considered only when a recurring problem exists.

When analyzing an intermittent problem, do the following:

1. Run the diagnostic test for the system board in loop mode at least 10 times.
2. If no error is detected, do not replace any FRU.
3. If any error is detected, replace the FRU. Rerun the test to verify that there are no more errors.

Undetermined Problems

The diagnostic problems does not identify which adapter or device failed, which installed devices are incorrect, whether a short circuit is suspected, or whether the system is inoperative.

Follow these procedures to isolate the failing FRU (do not isolate non-defective FRU).

NOTE: Verify that all attached devices are supported by the computer.

NOTE: Verify that the power supply being used at the time of the failure is operating correctly. (See “Power System Check” on page 59):

1. Power-off the computer.
2. Visually check them for damage. If any problems are found, replace the FRU.
3. Remove or disconnect all of the following devices:
 - Non-Acer devices
 - Printer, mouse, and other external devices
 - Battery pack
 - Hard disk drive
 - DIMM
 - PC Cards
4. Power-on the computer.
5. Determine if the problem has changed.
6. If the problem does not recur, reconnect the removed devices one at a time until you find the failing FRU.
7. If the problem remains, replace the following FRU one at a time. Do not replace a non-defective FRU:
 - System board
 - LCD assembly

Jumper and Connector Locations

Top View

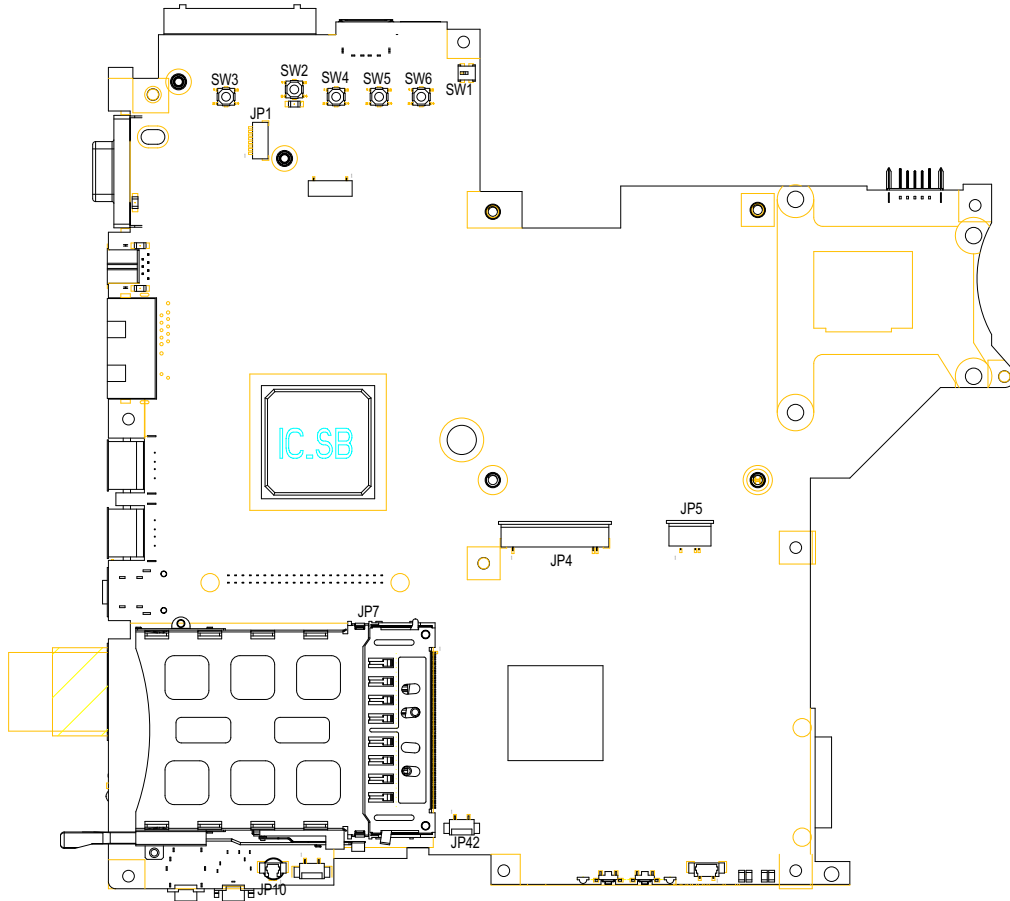

| | | | |
|-----|--------------------------|------|----------------------|
| SW3 | Power Switch | SW1 | Lid Switch |
| JP1 | Bluetooth Connector | JP5 | Touchpad Connector |
| SW2 | E-mail Switch | JP4 | Keyboard Connector |
| SW4 | Internet Browser Switch | JP42 | Speaker Connector |
| SW5 | Emanager Switch | JP7 | PCMCIA Slot |
| SW6 | User Programmable Switch | JP10 | Microphone Connector |

Bottom View

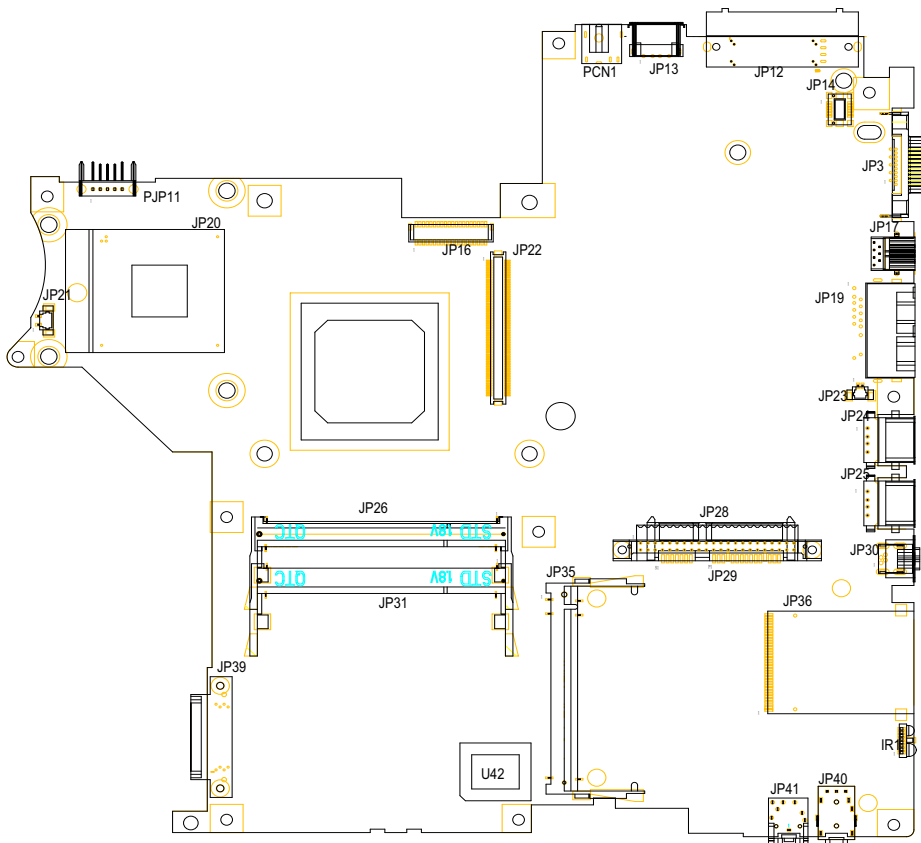

| | | | |
|-------|---|------|--|
| JP21 | Fan Connector | JP24 | USB Port |
| PJP11 | Battery Connector | JP25 | USB Port |
| JP20 | CPU Socket | JP30 | IEEE 1394 Port (No IEEE 1394 Port for this model) |
| JP16 | LVDS Connector | JP36 | Card Reader Connector(No Card Reader module for this model) |
| JP22 | VGA Board Connector | IR | Infrared Receiver (No FIR function for this model) |
| PCN1 | AC-IN | JP40 | Headphone out/line-out Jack (support SPDIF) |
| JP13 | USB Port | JP41 | Mic-in Jack |
| JP12 | Acer ezDock (No ezDock for this model) | JP28 | HDD Connector |
| JP14 | Modem Board Connector | JP35 | Wireless LAN Card Connector |
| JP3 | External Display Port | U42 | BIOS |
| JP17 | S-Video Port | JP26 | DDR2 Socket |
| JP19 | RJ11/RJ45 | JP31 | DDR2 Socket |
| JP23 | Modem Cable Connector | JP39 | ODD Connector |

FRU (Field Replaceable Unit) List

This chapter gives you the FRU (Field Replaceable Unit) listing in global configurations of TravelMate 3210Z series products. Refer to this chapter whenever ordering for parts to repair or for RMA (Return Merchandise Authorization).

Please note that WHEN ORDERING FRU PARTS, you should check the most up-to-date information available on your regional web or channel. For whatever reasons a part number change is made, it will not be noted on the printed Service Guide. For ACER AUTHORIZED SERVICE PROVIDERS, your Acer office may have a DIFFERENT part number code from those given in the FRU list of this printed Service Guide. You MUST use the local FRU list provided by your regional Acer office to order FRU parts for repair and service of customer machines.

NOTE: To scrap or to return the defective parts, you should follow the local government ordinance or regulations on how to dispose it properly, or follow the rules set by your regional Acer office on how to return it.

Exploded Diagram

The System

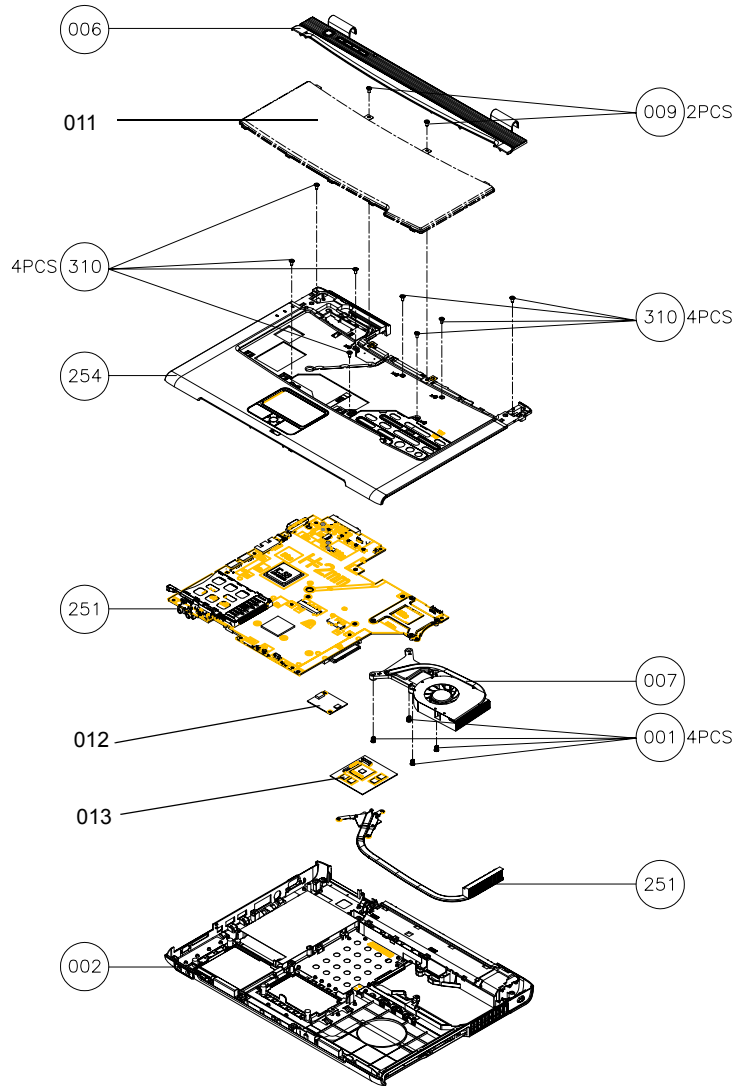

Upper Case Assembly

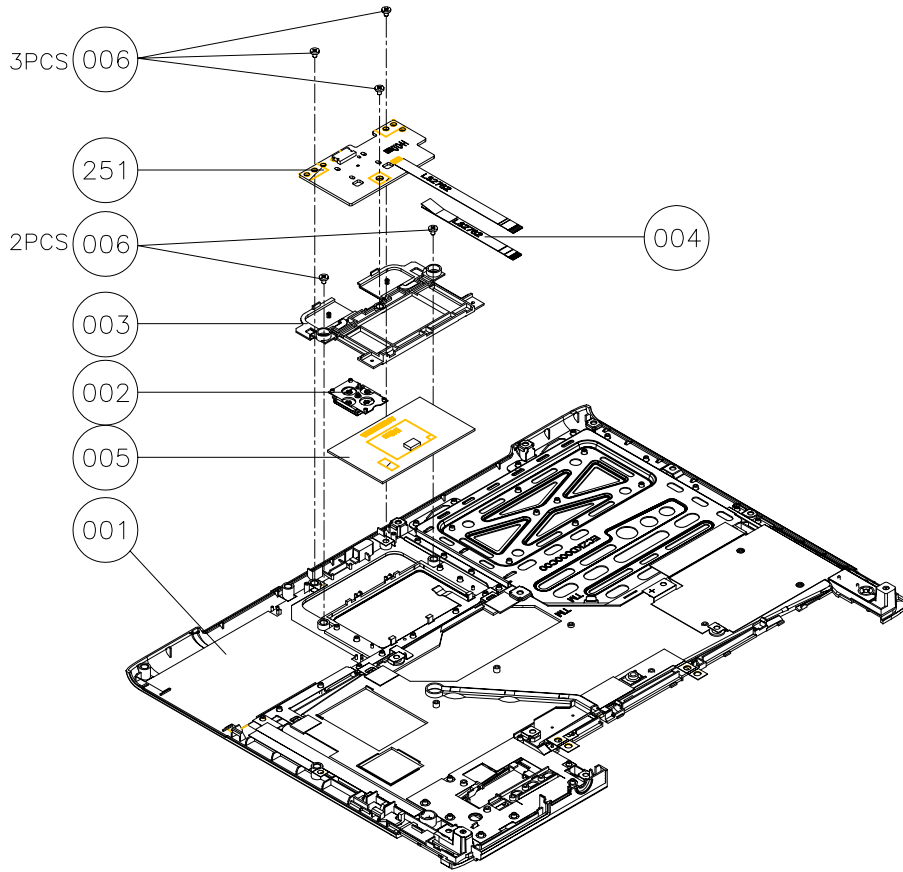

Lower Case Assembly

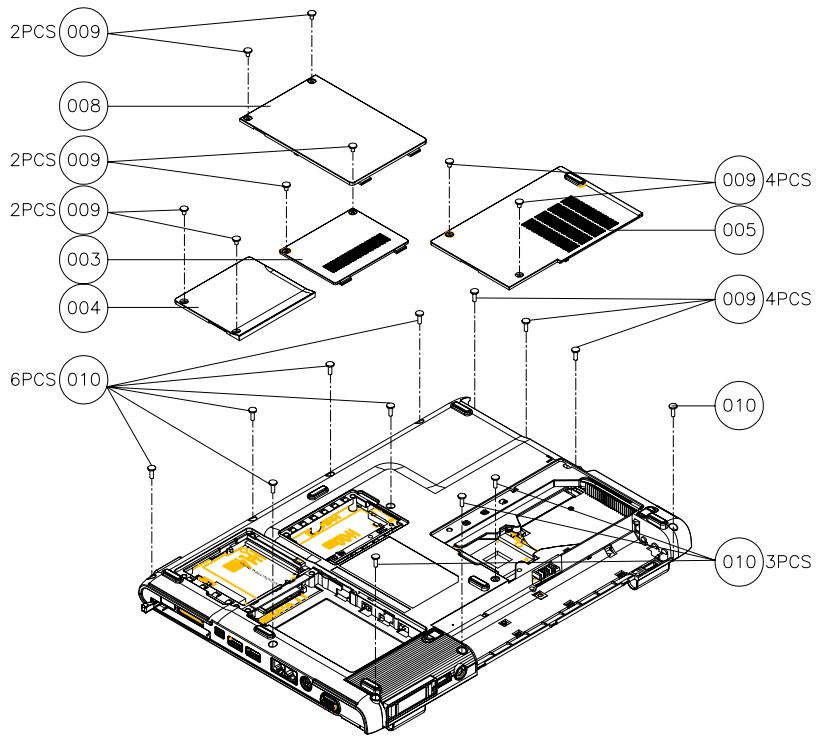

LCD Module

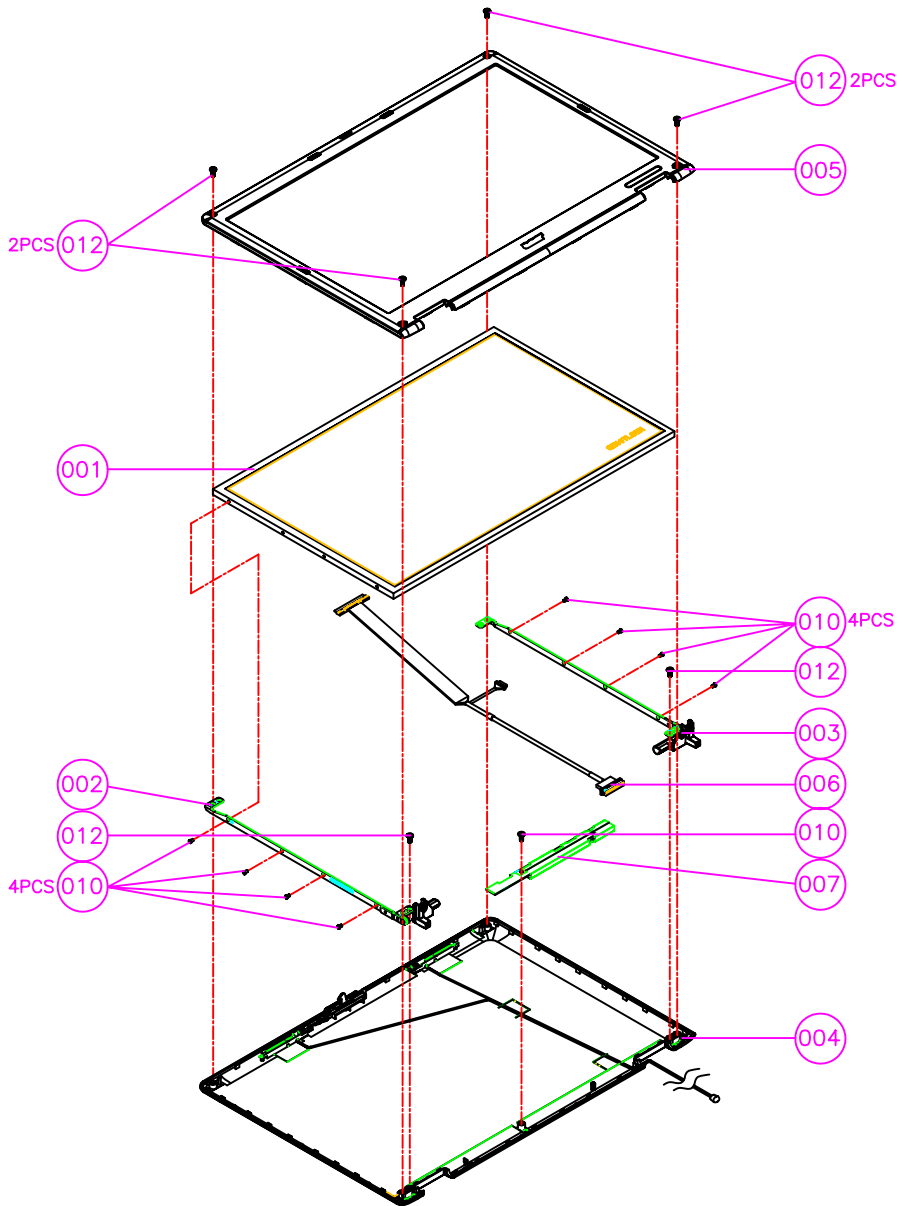



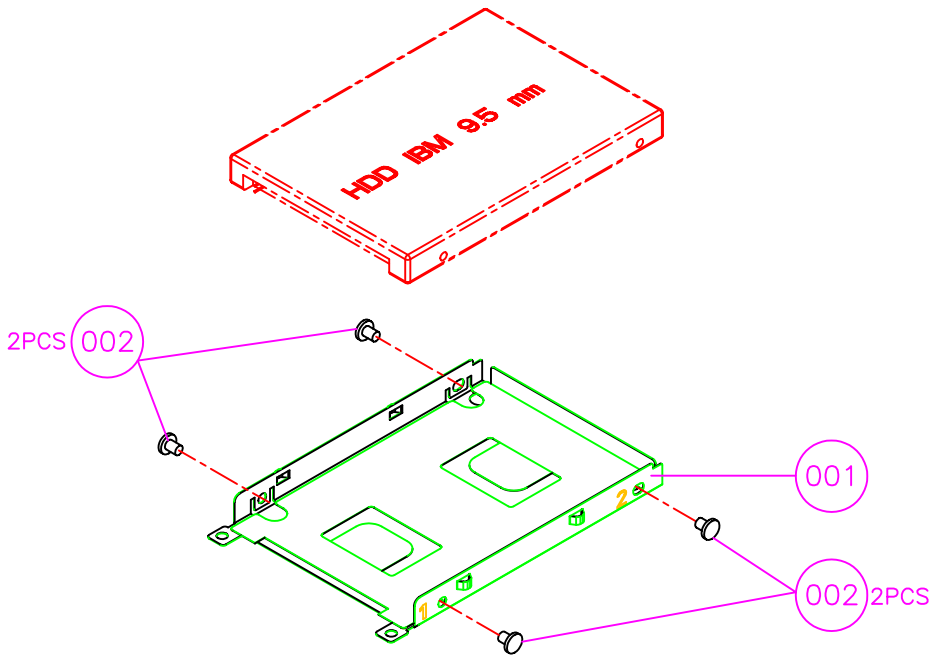

HDD Module

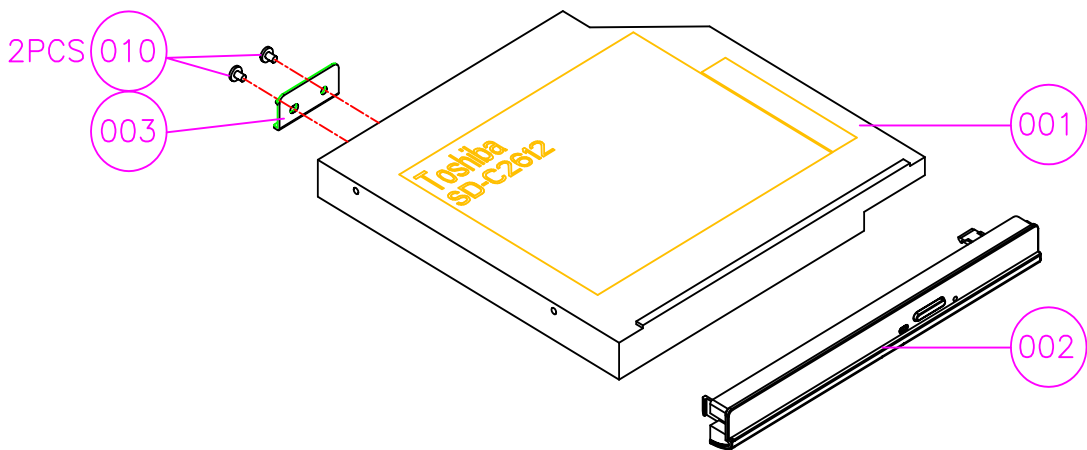

ODD Module

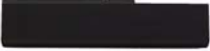

TravelMate 2400/3210/3220 FRU List

| Picture | No. | Part Name and Description | Part Number |
|---|-------------------------|--|--------------|
| Adapter | | | |
| | NS (Not Show) | ADAPTER 3 PIN 65W DELTA SADP-65KB BEF 19V 3PIN | AP.06501.006 |
| | | ADAPTER 3 PIN 65W LITEON PA-1650-02CO 65W 3 PIN | AP.06503.007 |
| | | ADAPTER 3 PIN 65W HIPRO HP-OK066B13CP 3P 65W | AP.0650A.004 |
| Battery | | | |
|  | NS | BATTERY LI-ION 6 CELLS-SANYO 2000mAH UR18650F | BT.00603.001 |
| | | BATTERY LI-ION 6 CELLS-SONY 2000mAH US18650G4 | BT.00604.004 |
| | | BATTERY LI-ION 6 CELLS-SANYO 2400mAH UR18650F | BT.00604.001 |
| | | BATTERY LI-ION 6 CELLS-SONY 2400mAH US18650G7 | BT.00604.001 |
| | NS | BATTERY LI-ION 9 CELLS-SANYO 2400mAH UR18650F | BT.00903.002 |
| Board | | | |
|  | The System-012 | MODEM BOARD FOXCONN T60M845.01 | 54.A70V5.001 |
|  | NS | BLUETOOTH CARD WNC 91.BU513.002 | 54.A70V5.002 |
|  | NS | MINI PCI WIRELESS BOARD 802.11 b+g INTEL WM3B2200/CH11 | KI.CAX01.008 |
|  | Upper Case Assembly-251 | T/P BOARD W/FFC CABLE | 55.A70V5.001 |

TravelMate 2400/3210/3220 FRU List

| Picture | No. | Part Name and Description | Part Number |
|---|-------------------------|------------------------------|--------------|
|  | The System-013 | VGA BOARD M26P 64MB | 55.A70V5.002 |
| Cable | | | |
|  | Upper Case Assembly-004 | FFC CABLE - T/P TO T/P BOARD | 50.A70V5.001 |
|  | NS | BLUETOOTH CABLE | 50.A70V5.002 |
|  | NS | MODEM CABLE | 50.A70V5.003 |
| | NS | POWER CORD-AUS | 27.A70V5.001 |
| | NS | POWER CORD-CHINA | 27.A70V5.002 |
| | NS | POWER CORD-DENMARK | 27.A70V5.003 |
| | NS | POWER CORD-EC | 27.A70V5.004 |
| | NS | POWER CORD-INDIA | 27.A70V5.005 |
| | NS | POWER CORD-ISREL | 27.A70V5.006 |
| | NS | POWER CORD-ITALIAN | 27.A70V5.007 |
| | NS | POWER CORD-JP | 27.A70V5.008 |
| | NS | POWER CORD-KOREA | 27.A70V5.009 |
| | NS | POWER CORD-SOUTH AFRICA | 27.A70V5.010 |
| | NS | POWER CORD-SWISS | 27.A70V5.011 |
| | NS | POWER CORDTWN | 27.A70V5.012 |
| | NS | POWER CORD-UK | 27.A70V5.013 |
| CABLE | NS | POWER CORD-US | 27.A70V5.014 |
| Case/Cover/Bracket Assembly | | | |
|  | The System-006 | MIDDLE COVER - TM | 42.TAAV5.001 |

TravelMate 2400/3210/3220 FRU List

| Picture | No. | Part Name and Description | Part Number |
|---|---|----------------------------|--------------|
|  | The System-254; Upper Case Assembly-001 | UPPER CASE-TM | 60.TAAV5.001 |
|  | The System-002 | LOWER CASE- UMA | 60.A70V5.002 |
| | NS | LOWER CASE- NON UMA | 60.A70V5.003 |
|  | Upper Case Assembly-002 | 4 - WAY BUTTON | 42.A70V5.002 |
|  | Upper Case Assembly-003 | TP SUPPORT | 33.A70V5.001 |
|  | Lower Case Assembly-003 | DIMM COVER | 42.A70V5.003 |
|  | Lower Case Assembly-004 | PCI DOOR | 42.A70V5.005 |
|  | Lower Case Assembly-005 | THERMAL DOOR | 42.A70V5.006 |
| Communication Module | | | |
| | NS | ANTENNA ASSY | 50.A70V5.004 |
| CPU/Processor | | | |
| | NS | CELERON M 350 (1.3G 1M) C0 | KC.NC001.350 |
| | NS | CELERON M 360 (1.4G 1M) C0 | KC.NC001.360 |
| | NS | CELERON M 370 (1.5G 1M) C0 | KC.NC001.370 |





TravelMate 2400/3210/3220 FRU List

| Picture | No. | Part Name and Description | Part Number |
|---|----------------|--|--------------|
| | NS | INTEL PENTIUM M DOTHAN 1.6GHZ 2M UFCBGA SL7EG B-1 STEPPING | KC.N0001.725 |
| | NS | INTEL PENTIUM M 1.6G 2M 533FSB uFCPGA2 SL86G C-1 STEPPING | KC.N0001.730 |
| | NS | INTEL PENTIUM M 1.73G 2M 533FSB uFCPGA2 SL7SA C-1 STEPPING | KC.N0001.740 |
| | NS | INTEL PENTIUM M 1.87G 2M 533FSB uFCPGA2 SL7S9 C-1 STEPPING | KC.N0001.750 |
| | NS | INTEL PENTIUM M 2.0G 2M 533FSB uFCPGA2 SL7SM C-1 STEPPING | KC.N0001.760 |
| Combo Drive | | | |
|  | ODD Module | DVD/CDRW COMBO MODULE 24X PHILIPS SCB5265 | 6M.A70V5.001 |
| | ODD Module-001 | DVD/CDRW COMBO DRIVE 24X PHILIPS SCB5265 | KO.02403.007 |
| | ODD Module-002 | DVD/CDRW COMBO BEZEL | 42.A70V5.007 |
|  | ODD Module-003 | ODD BRACKET | 33.A70V5.002 |
| | | | |
| | ODD Module | DVD/CDRW COMBO 24X MODULE PANASONIC UJDA-770 | 6M.A70V5.002 |
| | ODD Module-001 | DVD/CDRW COMBO 24X DRIVE PANASONIC UJDA-770 | KO.02406.013 |
| | ODD Module-002 | DVD/CDRW COMBO BEZEL | 42.A70V5.007 |
| | ODD Module-003 | ODD BRACKET | 33.A70V5.002 |
| DVD RW Drive | | | |
| | ODD Module | DVD DUAL MODULE 8X LITE-ON SOSW-833S (DL) TRAY IN | 6M.A70V5.004 |
| | ODD Module-001 | DVD DUAL 8X DRIVE LITE-ON SOSW-833S (DL) | KU.00804.012 |
| | ODD Module-002 | DVD DUAL BEZEL - TRAY IN | 42.A70V5.008 |
| | ODD Module-003 | ODD BRACKET | 33.A70V5.002 |







TravelMate 2400/3210/3220 FRU List

| Picture | No. | Part Name and Description | Part Number |
|---|----------------|--|--------------|
| | ODD Module | DVD DUAL MODULE 8X HLDS GWA-4082N (DL) | 6M.A70V5.007 |
| | ODD Module-001 | DVD DUAL 8X DRIVE HLDS GWA-4082N (DL) | KU.0080D.016 |
| | ODD Module-002 | DVD DUAL BEZEL - TRAY IN | 42.A70V5.008 |
| | ODD Module-003 | ODD BRACKET | 33.A70V5.002 |
| | ODD Module | SUPER MULTI MODULE 8X PANASONIC UJ-840BAA (DL) | 6M.A70V5.008 |
| | ODD Module-001 | SUPER MULTI 8X DRIVE PANASONIC UJ-840BAA | KU.00807.011 |
| | ODD Module-002 | SUPER MULIT BEZEL | 42.A70V5.010 |
| | ODD Module-003 | ODD BRACKET | 33.A70V5.002 |
| HDD Module | | | |
|  | HDD Module | HDD 40G 4200PRM SEAGATE ST94019A | KH.04001.010 |
| | HDD Module | HDD 40G 2.5 IN. 4200RPM TOSHIBA PLUTO MK4025GAS | KH.04004.002 |
| | HDD Module | HGST 40G 2.5" 4200 MORAGA+ HTS424040M9AT00 13G1132 FW:A71A | KH.04007.012 |
| | HDD Module | HDD 60GB 2.5 IN. 4200RPM SEAGATE N2 ST960821A F/W: 3.01 | KH.06001.002 |
| | HDD Module | HDD 60G 2.5IN. 4200RPM TOSHIBA PLUTO MK6025GAS 2M F/W KA200A | KH.06004.003 |
| | HDD Module | HDD 60GB 2.5IN. 4200RPM MORAGA 60G IC25N060ATMR04-0 08K0634 F/S:AD4A | KH.06007.006 |
| | HDD Module | HDD 80GB 2.5 IN. 4200RPM SEAGATE N2 ST9808210A F/W: 3.01 | KH.08001.012 |
| | HDD Module | HDD 80GB 2.5IN. 4200RPM TOSHIBA PLUTO MK8025GAS | KH.08004.001 |
| | HDD Module | HDD 80GB 2.5IN. 4200RPM HGST MORAGA IC25N080ATMR04-0 | KH.08007.007 |
| | HDD Module | HDD 100G 4200PRM SEAGATE ST9100822A F/W:3.01 | KH.10001.001 |
| | HDD Module | HDD 100GB 2.5IN. 4200RPM TOSHIBA PLUTO MK1031GAS F/W AA20 | KH.10004.001 |
|  | HDD Module-001 | HDD BRACKET | 33.A70V5.003 |







TravelMate 2400/3210/3220 FRU List

| Picture | No. | Part Name and Description | Part Number |
|---|-------------------------|---|--------------|
|  | Lower Case Assembly-008 | HDD DOOR | 42.A70V5.011 |
| Keyboard | | | |
|  | The System-011 | KEYBOARD DARFON CHINESE | KB.T5902.001 |
| | | KEYBOARD DARFON US INTERNATIONAL | KB.T5902.002 |
| | | KEYBOARD DARFON THAI | KB.T5902.003 |
| | | KEYBOARD DARFON GERMAN | KB.T5902.004 |
| | | KEYBOARD DARFON UK | KB.T5902.005 |
| | | KEYBOARD DARFON ITALIAN | KB.T5902.006 |
| | | KEYBOARD DARFON FRENCH | KB.T5902.007 |
| | | KEYBOARD DARFON SWISS/G | KB.T5902.008 |
| | | KEYBOARD DARFON BELGIUM | KB.T5902.009 |
| | | KEYBOARD DARFON SPANISH | KB.T5902.010 |
| | | KEYBOARD PORTUGUESE | KB.T5902.011 |
| | | KEYBOARD CZECH | KB.T5902.012 |
| | | KEYBOARD HUNGARIAN | KB.T5902.013 |
| | | KEYBOARD RUSSIAN | KB.T5902.014 |
| | | KEYBOARD SWEDEN | KB.T5902.015 |
| | | KEYBOARD NORWEGIAN | KB.T5902.016 |
| | | KEYBOARD DANISH | KB.T5902.017 |
| | | KEYBOARD ARABIC | KB.T5902.018 |
| | | KEYBOARD BRAZILIAN PORTUGUESE | KB.T5902.019 |
| | | KEYBOARD CANADIAN FRENCH | KB.T5902.020 |
| | | KEYBOARD GREEK | KB.T5902.021 |
| | | KEYBOARD TURKISH | KB.T5902.022 |
| | | KEYBOARD HEBREW | KB.T5902.023 |
| | | KEYBOARD SLOVENIA/CROATIA) | KB.T5902.024 |
| LCD Module | | | |
| | LCD Module | ASSY LCD MODULE 14 .1 WXGA NON GLARE QDI (N141V2 QD14TL01 REV 01) W/ ANT - TM | 6M.TAAV5.003 |
|  | LCD Module-001 | LCD 14 .1 WXGA NON GLARE QDI N141V2 QD14TL01 REV 01 | LK.14109.004 |
|  | LCD Module-007 | LCD INVERTER | 19.A70V5.001 |

TravelMate 2400/3210/3220 FRU List

| Picture | No. | Part Name and Description | Part Number |
|---|---------------------|--|--------------|
|  | LCD Module-006 | LCD WIRE CABLE | 50.A70V5.005 |
|  | LCD Module-004 | LCD PANEL WITH LOGO W/ANTENNA - TM | 60.TAAV5.002 |
|  | LCD Module-005 | LCD BEZEL | 60.A70V5.006 |
|  | LCD Module-002, 003 | LCD BRACKET SET | 6K.A70V5.001 |
| | | | |
| | LCD Module | ASSY LCD MODULE 14.1 WXGA NON GLARE CMO (N141I 1-L03) W/ANT-TM | 6M.TAAV5.004 |
|  | LCD Module-001 | LCD 14.1 WXGA NON GLARE CMO (N141I 1-L02) | LK.1410D.004 |
|  | LCD Module-007 | LCD INVERTER | 19.A70V5.001 |
|  | LCD Module-006 | LCD WIRE CABLE | 50.A70V5.005 |

TravelMate 2400/3210/3220 FRU List

| Picture | No. | Part Name and Description | Part Number |
|---|---------------------|--|--------------|
|  | LCD Module-004 | LCD PANEL WITH LOGO W/ANTENNA - TM | 60.TAAV5.002 |
|  | LCD Module-005 | LCD BEZEL | 60.A70V5.006 |
|  | LCD Module-002, 003 | LCD BRACKET SET | 6K.A70V5.001 |
| | | | |
| | LCD Module | ASSY LCD MODULE 14 .1 WXGA NON GLARE QDI (N141V2 QD14TL01 REV 01) W/O ANT - TM | 6M.TAAV5.007 |
|  | LCD Module-001 | LCD 14 .1 WXGA NON GLARE QDI N141V2 QD14TL01 REV 01 | LK.14109.004 |
|  | LCD Module-007 | LCD INVERTER | 19.A70V5.001 |
|  | LCD Module-006 | LCD WIRE CABLE | 50.A70V5.005 |
|  | LCD Module-004 | LCD PANEL WITH LOGO W/O ANTENNA - TM | 60.TAAV5.003 |





TravelMate 2400/3210/3220 FRU List

| Picture | No. | Part Name and Description | Part Number |
|---|---------------------|--|--------------|
|  | LCD Module-005 | LCD BEZEL | 60.A70V5.006 |
|  | LCD Module-002, 003 | LCD BRACKET SET | 6K.A70V5.001 |
| | LCD Module | ASSY LCD MODULE 14.1 WXGA NON GLARE CMO (N141I 1-L03) W/O ANT-TM | 6M.TAAV5.008 |
|  | LCD Module-001 | LCD 14.1 WXGA NON GLARE CMO (N141I 1-L02) | LK.1410D.004 |
|  | LCD Module-007 | LCD INVERTER | 19.A70V5.001 |
|  | LCD Module-006 | LCD WIRE CABLE | 50.A70V5.005 |
|  | LCD Module-004 | LCD PANEL WITH LOGO W/O ANTENNA - TM | 60.TAAV5.003 |
|  | LCD Module-005 | LCD BEZEL | 60.A70V5.006 |

TravelMate 2400/3210/3220 FRU List

| Picture | No. | Part Name and Description | Part Number |
|---|---------------------|---|--------------|
|  | LCD Module-002, 003 | LCD BRACKET SET | 6K.A70V5.001 |
| Mainboard | | | |
|  | The System-251 | MAINBOARD 915PM FOR VGA GLAN W/ READER PCMCIA SLOT W/O CPU MEMORY | LB.TAA02.002 |
| | | MAINBOARD 915GM UMA GLAN W/ READER PCMCIA SLOT W/O CPU MEMORY | LB.TAA02.001 |
| | | MAINBOARD 910GML UMA GLAN W/ PCMCIA SLOT W/O READER CPU MEMORY | LB.TA902.001 |
| | NS | PCMCIA SLOT | 22.A70V5.001 |
| Memory | | | |
|  | NS | MEMORY IFX 256MB/ 533MHZ, HYS64T32000HDL-3.7-A | KN.25602.023 |
| | | MEMORY DDRII533 256MB NANYA NT256T64UH4A0FN-37B | KN.25603.020 |
| | | MEMORY SAMSUNG 512MB/ 533MHZ, M470T3354BG0-CD5 | KN.2560B.011 |
| | | MEMORY DDRII 533 256MB HYNIX HYMP532S64P6-C4 | KN.2560G.006 |
| | | MEMORY IFX 512MB/ 533MHZ, HYS64T64020HDL-3.7-A | KN.51202.021 |
| Heatsink | | | |
|  | The System-007 | CPU THERMAL | 60.A70V5.007 |
|  | The System-251 | VGA THERMAL | 60.A70V5.008 |
| Pointing Device | | | |

TravelMate 2400/3210/3220 FRU List

| Picture | No. | Part Name and Description | Part Number |
|---|-------------------------|---------------------------|--------------|
|  | Upper Case Assembly-005 | TOUCHPAD | 56.A70V5.001 |
| Speaker | | | |
|  | NS | SPEAKER SET (R&L) | 23.A70V5.002 |
| Miscellaneous | | | |
|  | NS | LCD RUBBER PAD | 47.A70V5.001 |
|  | NS | LCD SCREW PAD | 47.A70V5.002 |
|  | NS | LCD RUBBER | 47.A70V5.003 |
| | NS | NAME PLATE - TM3210Z | TBD |
| | NS | RUBBER FOOT - ONE PIN | 47.A70V5.004 |
| | NS | RUBBER FOOT - TWO PINS | 47.A70V5.005 |
| SCREW | | | |
| SCREW | NS | SCREW M2*3(NL) | 86.A70V5.001 |
| SCREW | NS | SCREW M2*4 | 86.A70V5.002 |
| SCREW | NS | SCREW M2*6 | 86.A70V5.003 |
| SCREW | NS | SCREW M2*6(p Ni) | 86.A70V5.004 |
| SCREW | NS | SCREW M2.5*4(NL) | 86.A70V5.005 |
| SCREW | NS | SCREW M2.5*6(NL) | 86.A70V5.006 |
| SCREW | NS | SCREW M2.5*8(NL) | 86.A70V5.007 |
| SCREW | NS | SCREW M3*4 (NL) | 86.A70V5.008 |
| SCREW | NS | SCREW THERMAL SCREW ASSY | 86.A70V5.009 |

A

AFLASH Utility 41
Audio 25

B

Battery Pack 47
BIOS 21

- package 21
- password control 21
- ROM size 21
- ROM type 21
- vendor 21
- Version 21

 BIOS Supports protocol 21
BIOS Utility 31

- Basic System Settings 37
- Navigating 32
- Startup Configuration 38
- System Security 40

 Board Layout

- Bottom View 5, 74
- Top View 4, 73

C

Cache

- controller 21
- size 21

 CardBus 26

D

DIMM

- external 48, 52
- removing 48, 52

 Disassembly

- Battery Pack 46
- LCD Module 55
- Procedure Flowchart 45

 Disassemblyt

- the Main Unit 53

 Display 3
DVD-ROM Interface 24

E

Error Symptom-to-Spare Part Index 61
External CD-ROM Drive Check 58
External Diskette Drive Check 58

F

Features 1
Flash Utility 41
Floppy Disk

- removing the 55

 FRU (Field Replaceable Unit) List 75

H

Hard disk 23
HDD 23
Hot Keys 16

I

Indicators 12
Intermittent Problems 70

K

Keyboard 27
Keyboard or Auxiliary Input Device Check 58

L

L2 cache 21

M

Memory Check 58
Modem 22

N

num lock

- on indicator 12

P

Panel 6

- Bottom 11
- left 6

 PC Card 12, 26
PCMCIA 26
Power System Check 59

- Battery Pack 60

 Processor 21

S

Second Level Cache 21
System

- Block Diagram 3

 System Diagnostic Diskette 31

System Memory 21
System Utilities 31
System Utility Diskette 31

T

Touchpad Check 60
Troubleshooting 57

U

Undetermined Problems 71
USB 26
utility
 BIOS 31

V

Video 26